

COMPLETE CATALOGUS



Voor een perfect klimaat

De innovatieve **heating-**,
cooling- en **lighting-**assortiment



De intelligente oplossing met infrarood kortegolfttechnologie

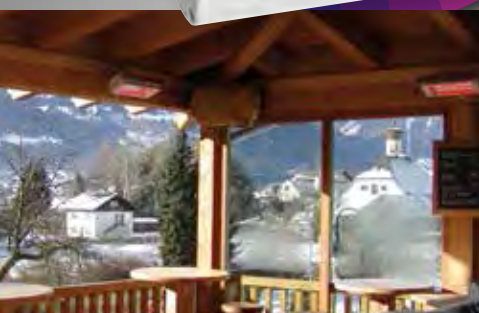

HEATING

Als koploper in de infrarood kortegolftechnologie hebben wij inmiddels bijna 25 jaar productervaring. De verwarmingstoestellen uit de begintijd zijn hoog efficiënte high-tech-verwarmingssystemen geworden, die geschikt zijn voor vrijwel alle denkbare toepassingen in het particuliere, zakelijke, industriële en openbare gebied: indoor of outdoor, mobiel of vast geïnstalleerd, individuele stralers of complete systeemoplossingen, optioneel uitgebreid met unieke koeling, licht en besturing.

Wie kent het niet: overdag is het in de zon niet uit te houden, maar als het donker wordt, daalt de temperatuur snel en wordt het fris. Precies daarvoor hebben wij PERFECTCLIME® ontwikkeld, de unieke combinatie van verwarmen en koelen in één: beproefde infrarood kortegolftechnologie gecombineerd met de gepatenteerde PERFECTCLIME®-optie, zorgt direct voor weldadige warmte of aangename koeling onder het motto: PERFECTCLIME at any time.

BURDA
PERFECT
S I

ALL
uit één

COOLING

BURDA
WORLDWIDE
TECHNOLOGIES



Onze hoogwaardige verlichtingssystemen, als combinatie of als verlichtingsstrip, zijn in design en techniek perfect afgestemd op onze warmtestralersystemen, zowel indoor als outdoor. De verlichtingsstrips in aanvulling op bestaande verwarmingssystemen vormen een hoogwaardige en elegante productfamilie, die altijd een fraai uiterlijk en het juiste licht mogelijk maken: heldere werkplekverlichting of kleurige verlichting voor horeca of evenementen; de gebruiksmogelijkheden zijn vrijwel onbegrensd.

LIGHTING

BURDA
CLIMATE
SINCE 1990

LES
in hand



QUARTZ INFRA-RED HEATER CONTROLLER

Ons complete assortiment aan accessoires en besturingen maakt effectieve, intelligente en bijzonder kosteneffectieve installaties mogelijk in alle denkbare indoor- en outdoorgebieden. Complete automatisering door timers, dimmers, bewegingsmelders en andere sensoren, evenals een groot aantal bevestigingsmogelijkheden zijn de perfecte aanvulling voor een gebruikersvriendelijke installatie en gebruik voor de hoogste effectiviteit, zelfs bij grote en complexe projecten.

CONTROL

BURDAWTG

De slimme manier



INTELLIGENTE OPLOSSINGEN

Als pionier op het gebied van de korte golf infraroodtechniek beschikken wij over de kennis en ervaring om de technologie verder te ontwikkelen. Onze innovatieve producten zijn het bewijs hiervan. Onze drive is het produceren van efficiënte, duurzame en energiebesparende directe verwarmings- en verkoelingsproducten. Oplossingen op maat, afgestemd op de omgeving en de wensen van de klant, zorgen voor onbeperkte mogelijkheden.

INTELLIGENTE ANTWOORDEN

Wij luisteren naar de wensen en behoeften van de klant om zo de juiste oplossing te bieden. BURDA staat voor: klantgeoriënteerd, gepassioneerd, flexibel en betrouwbaar.

INTELLIGENT CONCEPT

De hoge eisen die wij stellen aan het productieproces, in combinatie met het gebruik van hoogwaardige materialen, maken het mogelijk om kwalitatief functionele en efficiënte topproducten te leveren. Hierdoor is BURDA wereldwijd een begrip op het gebied van infraroodverwarming.

INTELLIGENTE VOORDELEN

- Origineel sinds 1990
- Unieke kwaliteitsstandaard
- Hoogwaardige productie en grote productiediepte
- Optimale kwaliteit gebruikte materialen
- Verhoogde duurzaamheid en groot aantal branduren
- Efficiënt
- Emissievrij en milieuvriendelijk
- Breed infraroodspectrum (tot 18kW)
- Uitgebreid assortiment qua kleuren en modellen
- Hoogwaardig design
- Duurzaam en waterproof aluminium



INTELLIGENT GEBRUIK



Gastronomie/hotellerie



Zwembad



Hallen (productie, magazijnen, etc.)



Kerk



Balkon/terras/serre



Garage/werkplaats



Hangar

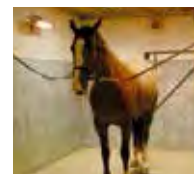

Dierhouderij

 waterdicht



100% warmte bij
80% minder licht!



IP20 = Indoor
IP24 = Indoor und Outdoor

IP65 = Outdoor
IP67 = Outdoor

Inhoud

TERM 2000	Zijde 6-7
TERM TOWER	Zijde 8-9
TERM IR SPA, TERM 2500 VOLCANO, TERM 2000 CVH	Zijde 10-11
LIGHT	Zijde 12-13
SMART	Zijde 14-15
PERFECTCLIME	Zijde 16-17
CONTROL	Zijde 18-19
ADD ON	Zijde 20-21
MEER OMZET DOOR VERKOOPBEVORDERING	Zijde 22
PRODUCTOVERZICHT	Zijde 23-37
WAT IS INFRAROOD?	Zijde 38
GOED OM TE WETEN	Zijde 39





TERM 2000

Onze TERM 2000 is ontwikkeld voor de ongecompliceerde verwarming van indoor- en outdoorgebieden. Hij is uitgerust met een speciaal daarvoor ontwikkelde en vervaardigde gouden infraroodbuis met een zeer hoge levensduur tot 5.000 uur. Afhankelijk van het toepassingsgebied en de gebruikseisen is de TERM 2000 verkrijgbaar als IP20, IP24, IP44 en compleet waterdicht als IP67, en als één-, twee- of driestralig (alleen IP67).

TOEPASSINGSGBIEDEN

Kantoor, drogen bij bouwwerkzaamheden, garage, kas, hal, huishouding, hotel, kerk, openbare gebouwen, restaurant/café, zwembad, terras, dierhouderij, werkplaats

61 cm



TERM 2000 IP67

Verkrijgbaar en te combineren met:

PERFECTCLIME

LOW GLARE

LIGHT



- 1 kW
- 1,5 kW
- 1,65 kW
- 2 kW



132 cm



TERM 2000 IP67 MULTI

Verkrijgbaar en te combineren met:

PERFECTCLIME

LOW GLARE

Beschikbaar met drie stralers

- 3 kW
- 3,3 kW
- 4 kW
- 4,95 kW
- 6 kW



51 cm



TERM 2000 IP24

LOW GLARE

- 1,5 kW
- 2 kW

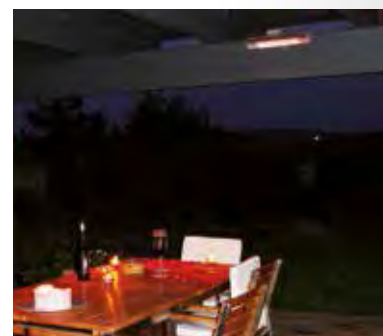

41 cm



TERM 2000 IP20 NO GLARE

NO GLARE

- 1 kW





TERM TOWER

Voor grote tenten of outdoor-gebieden zijn alle voordelen van de TERM-serie op te stellen of te hangen – als TERM TOWER of TERM TOWER HANGING! De TERM TOWER-serie die zeer geschikt is voor hotellerie en gastronomie biedt een optimale verwarmingsprestatie voor alle binnen- en buitengebieden, vooral waar het gebrek aan bevestigingsmogelijkheden het gebruik van andere systemen belemmerd heeft. Veelzijdige uitrustingsopties (bijv. licht) leveren vrijwel onbegrensde gebruiksmogelijkheden. Naar wens ook met tafel en asbak verkrijgbaar.

TOEPASSINGSGEBIEDEN

Hotel, openbare gebouwen, restaurant/café, zwembad, terras



TERM TOWER

Verkrijgbaar en te combineren met:



3 kW
4,5 kW
6 kW



TERM TOWER PALMS IP67

Verkrijgbaar en te combineren met:

PERFECTCLIME



4 kW
6 kW
8 kW



Beschikbaar met tafel en asbak



TERM TOWER HANGING HORIZONTAL IP65/IP67

Verkrijgbaar en te combineren met:

PERFECTCLIME



6 kW



TERM TOWER HANGING VERTICAL IP67

Verkrijgbaar en te combineren met:

PERFECTCLIME



6 kW





IR SPA

Wellness voor thuis met de infraroodsauna zonder cabine. Op het kleinste oppervlak kunnen de IR SPA saunawarmtestralers eenvoudig geplaatst worden, zelfs kleine badkamers kunnen zo snel in een wellness-oase veranderd worden. Slechts een gewoon stopcontact en weinig plaats is nodig om de dieptewarmte te verkrijgen voor de versterking van de weerstand van ons lichaam. Lange- en korte golf infraroodstralen worden geproduceerd door de infrarood sauna-warmtestraler. Het gelijkmatige infraroodveld wekt een temperatuur op van 45-50 graden Celsius, een aangename dieptewarmte die de doorbloeding en stofwisseling bevordert.

TOEPASSINGSGBIEDEN

Huishouding, hotel, zwembad



TERM 2500 VOLCANO



TERM 2000 CVH

De compacte, inklapbare standvoet en het tweevoudig regelbare vermogen tot max. 2.500 W maken de VOLCANO een universele alleskunner. Hij is eenvoudig te transporteren en onderscheidt zich door een grote flexibiliteit door zijn gebruiksmogelijkheden in zowel het particuliere als het zakelijke gebied.

De draagbare variant van de TERM 2000 is speciaal ontwikkeld voor het probleemloos en effectief drogen van verf en het verwarmen van andere materialen. Door het gewicht van slechts 1,5 kg is hij makkelijk te transporteren en zowel horizontaal als verticaal te gebruiken.

TOEPASSINGSGBIEDEN

Huishouding, hotel, kantoor, zwembad, werkplaats



LIGHT

Onze nieuwe 1- tot 4-stralige (50W, gU10) lichtsystemen van de TERM RL-serie zijn in design en functionaliteit perfect afgestemd op onze TERM 2000-warmtestraler-series. Ze vullen aanwezige TERM 2000-systemen optimaal aan en zorgen overal voor het passende licht waar het op de “juiste” helderheid aankomt. Naast onze lichtstrips uit de serie TERM RL hebben we 2- tot 4-stralige verwarmings-/lichtcombinatieapparaten in het assortiment, die gebaseerd zijn op onze beproefde TERM 2000-serie. Alle lichtsystemen zijn waterdicht conform IP65 en optimaal dimbaar of afzonderlijk stuurbaar; optimaal afgestemde dimmers zijn bij ons als accessoire verkrijgbaar.

TOEPASSINGSGEBIEDEN

Balkon, terras, tuinhuizen, hobbyruimtes



TERM 2000 LICHTSYSTEME IP65

Verkrijgbaar en te combineren met:

PERFECTCLIME



78 cm



1,1 kW

1,75 kW

2,1 kW

TERM 2000 L&H FIX IP65

Verkrijgbaar en te combineren met:

PERFECTCLIME



82,5 cm



1,1 kW

1,75 kW

2,1 kW

TERM 2000 L&H IP65

Verkrijgbaar en te combineren met:

PERFECTCLIME



191 cm



2,2 kW

3,5 kW

4,2 kW

TERM 2000 L&H IP65

Verkrijgbaar en te combineren met:

PERFECTCLIME





SMART

De compacte en ongecompliceerde SMART-serie slaat niet alleen een goed figuur in de garage, op het balkon en terras, maar levert ook waardevolle diensten aan de industrie bij zowel de verwarming van specifieke plaatsen als bij het verwarmen en drogen van materialen. De grote reflector zorgt steeds voor een optimaal verwarmingsvermogen.

TOEPASSINGSGEBIEDEN

Kantoor, drogen bij bouwwerkzaamheden, garage, kas, hal, huishouding, hotel, kerk, restaurant/café, terras, dierhouderij, werkplaats



SMART IP24

Verkrijgbaar en te combineren met:



- 1,5 kW
- 2 kW
- 3 kW
- 4 kW
- 6 kW



PERFECTCLIME | LOW GLARE



SMART ADVERT IP24

Verkrijgbaar en te combineren met:



- 3 kW



PERFECTCLIME | LOW GLARE



SMART 2000 IP20

Verkrijgbaar en te combineren met:



- 1,5 kW
- 2 kW



LOW GLARE

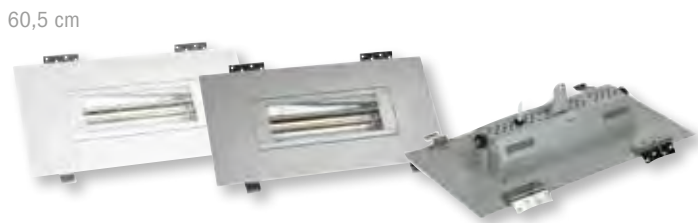

SMART FRAME IP20

Verkrijgbaar en te combineren met:



- 1,5 kW
- 2 kW



LOW GLARE



SMART TOWER IP20

Verkrijgbaar en te combineren met:



- 3 kW



LOW GLARE

De eerste **Heating** & **Cooling** sensatie

GEPATENTEERD

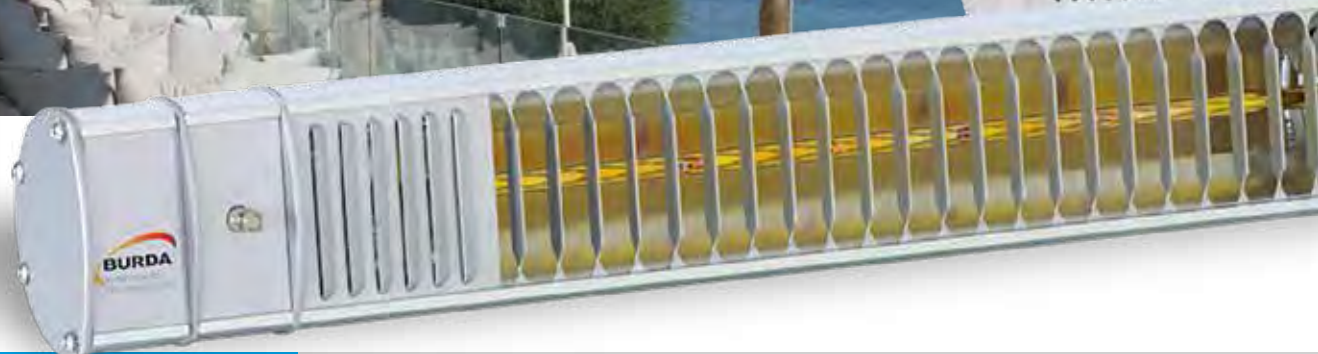
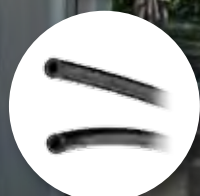

PERFECTCLIME®

Het eerste heating & cooling-concept met infrarood kortegolfttechnologie; gecombineerd in één straler! Comfortabele directe warmte of verfrissende koele lucht; het resultaat is steeds en overal de perfecte temperatuur. Gegarandeerde warmte met een druk op de knop, gebaseerd op de succesvolle TERM 2000 IP67 en SMART 2000 IP24 en de superfijne koelnevel van de geïntegreerde koelsproeier, leiden tot een comfortabele atmosfeer met vrijwel onbegrensde professionele en particuliere gebruiksmogelijkheden. PERFECTCLIME® is alleen bij ons verkrijgbaar!

TOEPASSINGSGBIEDEN

Balkon, terras, tuinhuizen, hobbyruimtes

70 cm

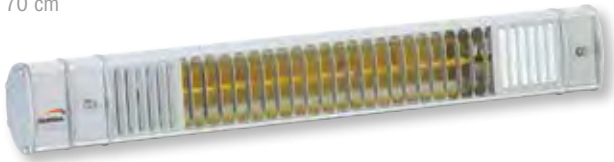

- 1 kW
- 1,65 kW
- 2 kW



TERM 2000

Verkrijgbaar en te combineren met:



87 cm



91 cm

- 1 kW
- 1,65 kW
- 2 kW



TERM 2000 L&H

Verkrijgbaar en te combineren met:



89 cm



TERM 2000 LICHTSYSTEME



55,5 cm

63 cm

111,5 cm

151,5 cm



Verkrijgbaar met
1 of 2 sproeiers

- 1,5 kW
- 2 kW
- 3 kW
- 4 kW
- 6 kW



SMART 2000

Verkrijgbaar en te combineren met:





CONTROL

Op maat gemaakt voor ons infraroodstraler- en verlichtingsassortiment bieden onze accessoires intelligente oplossingen voor het gebruik en de bediening van onze systemen. Voor een optimaal en individueel warmtemanagement zorgen dimmers, timers en afstandsbedieningen; eenvoudig en effectief.

DRAADLOZE DIMMERS

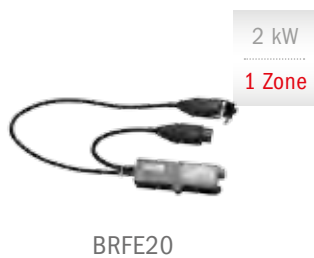

DIMMERS/TIMERS



BEWEGINGSMELDERS/TEMPERATUURSENSOREN





ADD ON

U zoekt naar een mogelijkheid om onze systemen in korte tijd te installeren en snel op te bouwen en te verwijderen? Dan is ons klem- en statiefassortiment geschikt voor u; daarmee is een stabiele plaatsing en snelle montage gegarandeerd.

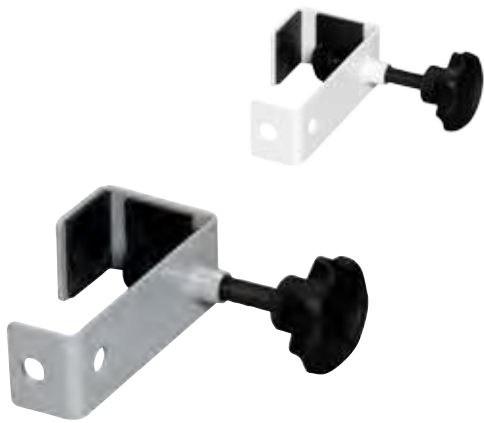

KLS1
Steunbalkklem met stergreep



KLS1K
Steunbalk- en paalbevestiging met klittenband



KLM4
Paalbevestiging 1-4



BHSS
Statief tot 210 cm

Meer omzet door verkoopbevordering

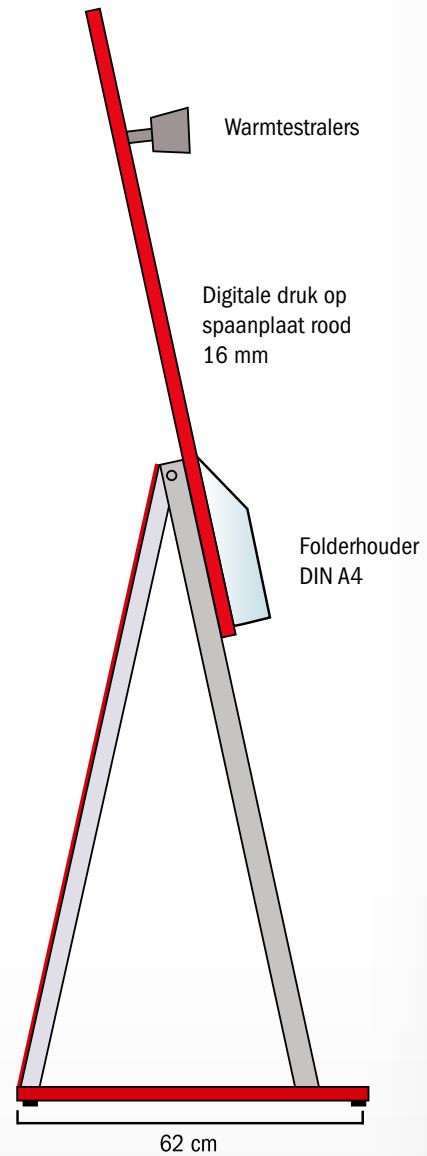

DEMONSTREER DE INNOVATIEVE INFRAROOD WARMTESTRALERS VAN BURDA!

Overtuig uw klanten met intelligente warmte met een druk op de knop. Met het nieuwe, slimme display trekt u de aandacht van uw klanten voor onze innovatieve warmtestralers. „Live in Action” is het enorme vermogen en de hoge warmteprestatie direct merkbaar.

Een tijdschakelklok, de sensor en een folderhouder, voor de gratis catalogi, zijn geïntegreerd.

PRODUCT OVERZICHT

VERMOGEN · MATERIAAL · CODE · EAN · IP AANDUIDING · AFMETINGEN
GEWICHT · UITRUSTING · SNOERLENGTE · STROOMAANSLUITING · BENAMING

VERMOGEN	MATERIAAL	CODE	EAN	IP AANDUIDING	AFMETINGEN (B x H x T in cm)	GEWICHT (in g)	UITRUSTING	SNOERLENGTE	STROOMA ANSLUITING
----------	-----------	------	-----	---------------	---------------------------------	-------------------	------------	-------------	-----------------------



TERM 2000 IP67

1 x 1,0 kW	Aluminium gepolijst	RCA100	4260051480503	IP67	45 x 9,5 x 12,5	2300	4	3m 3-adrig 1,5 mm ² , Schukostecker	1/N/PE ~ 230 V 50 Hz
1 x 1,0 kW	Aluminium gepolijst	PCRCA100	4260051481876	IP67	50 x 9,5 x 12,5	2700	1, 4	3m 3-adrig 1,5 mm ² , Schukostecker	1/N/PE ~ 230 V 50 Hz
1 x 1,0 kW	Aluminium gepolijst	PCRCA1002	4260051481920	IP67	55 x 9,5 x 12,5	2700	1, 4	3m 3-adrig 1,5 mm ² , Schukostecker	1/N/PE ~ 230 V 50 Hz
1 x 1,65 kW	Aluminium gepolijst	RCA165	4260051480237	IP67	61 x 9,5 x 12,5	2500	4	3m 3-adrig 1,5 mm ² , Schukostecker	1/N/PE ~ 230 V 50 Hz
1 x 1,65 kW	Aluminium gepolijst	PCRCA165	4260051481883	IP67	65 x 9,5 x 12,5	2700	1, 4	3m 3-adrig 1,5 mm ² , Schukostecker	1/N/PE ~ 230 V 50 Hz
1 x 1,65 kW	Aluminium gepolijst	PCRCA1652	4260051481937	IP67	70 x 9,5 x 12,5	2900	1, 4	3m 3-adrig 1,5 mm ² , Schukostecker	1/N/PE ~ 230 V 50 Hz
1 x 2,0 kW	Aluminium gepolijst	RCA200V	4260051480275	IP67	61 x 9,5 x 12,5	2500	4	3m 3-adrig 1,5 mm ² , Schukostecker	1/N/PE ~ 230 V 50 Hz
1 x 2,0 kW	Aluminium gepolijst	PCRCA200V	4260051481661	IP67	65 x 9,5 x 12,5	2700	1, 4	3m 3-adrig 1,5 mm ² , Schukostecker	1/N/PE ~ 230 V 50 Hz
1 x 2,0 kW	Aluminium gepolijst	PCRCA200V2	4260051481814	IP67	70 x 9,5 x 12,5	2900	1, 4	3m 3-adrig 1,5 mm ² , Schukostecker	1/N/PE ~ 230 V 50 Hz
1 x 1,0 kW	Aluminium gepolijst	UPCRCA100	4260051484372	IP67	50 x 9,5 x 12,5	2700	1, 2, 4	3m 3-adrig 1,5 mm ² , Schukostecker	1/N/PE ~ 230 V 50 Hz
1 x 1,0 kW	Aluminium gepolijst	UPCRCA1002	4260051484389	IP67	50 x 9,5 x 12,5	2700	1, 2, 4	3m 3-adrig 1,5 mm ² , Schukostecker	1/N/PE ~ 230 V 50 Hz
1 x 1,0 kW	Aluminium gepolijst	URCA100V	4260051485577	IP67	45 x 9,5 x 12,5	2300	2, 4	3m 3-adrig 1,5 mm ² , Schukostecker	1/N/PE ~ 230 V 50 Hz
1 x 1,5 kW	Aluminium gepolijst	UPCRCA150V	4260051485553	IP67	65 x 9,5 x 12,5	2700	1, 2, 4	3m 3-adrig 1,5 mm ² , Schukostecker	1/N/PE ~ 230 V 50 Hz
1 x 1,5 kW	Aluminium gepolijst	UPCRCA150V2	4260051485560	IP67	70 x 9,5 x 12,5	2900	1, 2, 4	3m 3-adrig 1,5 mm ² , Schukostecker	1/N/PE ~ 230 V 50 Hz
1 x 1,65 kW	Aluminium gepolijst	URCA165V	4260051483863	IP67	61 x 9,5 x 12,5	2500	2, 4	3m 3-adrig 1,5 mm ² , Schukostecker	1/N/PE ~ 230 V 50 Hz
1 x 1,65 kW	Aluminium gepolijst	UPCRCA165V	4260051484419	IP67	65 x 9,5 x 12,5	2700	1, 2, 4	3m 3-adrig 1,5 mm ² , Schukostecker	1/N/PE ~ 230 V 50 Hz
1 x 1,65 kW	Aluminium gepolijst	UPCRCA165V2	4260051484426	IP67	70 x 9,5 x 12,5	2900	1, 2, 4	3m 3-adrig 1,5 mm ² , Schukostecker	1/N/PE ~ 230 V 50 Hz
1 x 2,0 kW	Aluminium gepolijst	URCA200V	4260051484150	IP67	61 x 9,5 x 12,5	2500	4	3m 3-adrig 1,5 mm ² , Schukostecker	1/N/PE ~ 230 V 50 Hz
1 x 2,0 kW	Aluminium gepolijst	UPCRCA200V	4260051484457	IP67	65 x 9,5 x 12,5	2700	1, 2, 4	3m 3-adrig 1,5 mm ² , Schukostecker	1/N/PE ~ 230 V 50 Hz
1 x 2,0 kW	Aluminium gepolijst	UPCRCA200V2	4260051484488	IP67	70 x 9,5 x 12,5	2900	1, 2, 4	3m 3-adrig 1,5 mm ² , Schukostecker	1/N/PE ~ 230 V 50 Hz



TERM 2000 IP67 HIRSCHMANN

1 x 1,0 kW	Aluminium gepolijst	RCA100H	4260051489612	IP67	45 x 9,5 x 12,5	2300	4	3m 3-adrig 1,5 mm ² , Schukostecker met Hirschmannset	1/N/PE ~ 230 V 50 Hz
1 x 1,0 kW	Aluminium gepolijst	PCRCA100H	4260051481890	IP67	50 x 9,5 x 12,5	2700	1, 4	3m 3-adrig 1,5 mm ² , Schukostecker met Hirschmannset	1/N/PE ~ 230 V 50 Hz
1 x 1,0 kW	Aluminium gepolijst	PCRCA1002H	4260051481944	IP67	50 x 9,5 x 12,5	2700	1, 4	3m 3-adrig 1,5 mm ² , Schukostecker met Hirschmannset	1/N/PE ~ 230 V 50 Hz
1 x 1,65 kW	Aluminium gepolijst	RCA165H	4260051489544	IP67	61 x 9,5 x 12,5	2500	4	3m 3-adrig 1,5 mm ² , Schukostecker met Hirschmannset	1/N/PE ~ 230 V 50 Hz
1 x 1,65 kW	Aluminium gepolijst	PCRCA165H	4260051481906	IP67	65 x 9,5 x 12,5	2700	1, 4	3m 3-adrig 1,5 mm ² , Schukostecker met Hirschmannset	1/N/PE ~ 230 V 50 Hz
1 x 1,65 kW	Aluminium gepolijst	PCRCA1652H	4260051481951	IP67	70 x 9,5 x 12,5	2900	1, 4	3m 3-adrig 1,5 mm ² , Schukostecker met Hirschmannset	1/N/PE ~ 230 V 50 Hz
1 x 2,0 kW	Aluminium gepolijst	RCA200VH	4260051480565	IP67	61 x 9,5 x 12,5	2500	4	3m 3-adrig 1,5 mm ² , Schukostecker met Hirschmannset	1/N/PE ~ 230 V 50 Hz
1 x 2,0 kW	Aluminium gepolijst	PCRCA200VH	4260051481913	IP67	65 x 9,5 x 12,5	2700	1, 4	3m 3-adrig 1,5 mm ² , Schukostecker met Hirschmannset	1/N/PE ~ 230 V 50 Hz
1 x 2,0 kW	Aluminium gepolijst	PCRCA200V2H	4260051481968	IP67	70 x 9,5 x 12,5	2900	1, 4	3m 3-adrig 1,5 mm ² , Schukostecker met Hirschmannset	1/N/PE ~ 230 V 50 Hz
1 x 1,0 kW	Aluminium gepolijst	UPCRCA100H	4260051484402	IP67	50 x 9,5 x 12,5	2700	1, 2, 4	3m 3-adrig 1,5 mm ² , Schukostecker met Hirschmannset	1/N/PE ~ 230 V 50 Hz
1 x 1,0 kW	Aluminium gepolijst	UPCRCA1002H	4260051484396	IP67	50 x 9,5 x 12,5	2700	1, 2, 4	3m 3-adrig 1,5 mm ² , Schukostecker met Hirschmannset	1/N/PE ~ 230 V 50 Hz

VERMOGEN	MATERIAAL	CODE	EAN	IP AANDUIDING	AFMETINGEN (B x H x T in cm)	GEWICHT (in g)	UITRUSTING	SNOERLENGTE	STROOMA ANSLUITING
1 x 1,65 kW	Aluminium gepolijst	URCA165VH	4260051484181	IP67	61 x 9,5 x 12,5	2500	2, 4	3m 3-adrig 1,5 mm ² , Schuko-stecker met Hirschmannset	1/N/PE ~ 230 V 50 Hz
1 x 1,65 kW	Aluminium gepolijst	UPCRCA165VH	4260051485652	IP67	65 x 9,5 x 12,5	2700	1, 2, 4	3m 3-adrig 1,5 mm ² , Schuko-stecker met Hirschmannset	1/N/PE ~ 230 V 50 Hz
1 x 1,65 kW	Aluminium gepolijst	UPCRCA165V2H	4260051481951	IP67	70 x 9,5 x 12,5	2900	1, 2, 4	3m 3-adrig 1,5 mm ² , Schuko-stecker met Hirschmannset	1/N/PE ~ 230 V 50 Hz
1 x 2,0 kW	Aluminium gepolijst	URCA200VH	4260051484198	IP67	61 x 9,5 x 12,5	2500	2, 4	3m 3-adrig 1,5 mm ² , Schuko-stecker met Hirschmannset	1/N/PE ~ 230 V 50 Hz
1 x 2,0 kW	Aluminium gepolijst	UPCRCA200VH	4260051484501	IP67	65 x 9,5 x 12,5	2700	1, 2, 4	3m 3-adrig 1,5 mm ² , Schuko-stecker met Hirschmannset	1/N/PE ~ 230 V 50 Hz
1 x 2,0 kW	Aluminium gepolijst	UPCRCA200V2H	4260051484495	IP67	70 x 9,5 x 12,5	2900	1, 2, 4	3m 3-adrig 1,5 mm ² , Schuko-stecker met Hirschmannset	1/N/PE ~ 230 V 50 Hz



TERM 2000 COLOR IP67 (610 mm)

1 x 1,50 kW	Zuiver wit	URCAC150V9010	4260051485607	IP67	61 x 9,5 x 12,5	2500	2, 4	3m 3-adrig 1,5 mm ² , Schuko-stecker	1/N/PE ~ 230 V 50 Hz
1 x 1,65 kW	Zuiver wit	URCAC165V9010	4260051485614	IP67	61 x 9,5 x 12,5	2500	2, 4	3m 3-adrig 1,5 mm ² , Schuko-stecker	1/N/PE ~ 230 V 50 Hz
1 x 2,0 kW	Zuiver wit	URCAC200V9010	4260051485621	IP67	61 x 9,5 x 12,5	2500	2, 4	3m 3-adrig 1,5 mm ² , Schuko-stecker	1/N/PE ~ 230 V 50 Hz
1 x 1,5 kW	Diepzwart	URCAC150V9005	4260051486222	IP67	61 x 9,5 x 12,5	2500	2, 4	3m 3-adrig 1,5 mm ² , Schuko-stecker	1/N/PE ~ 230 V 50 Hz
1 x 1,65 kW	Diepzwart	URCAC165V9005	4260051486239	IP67	61 x 9,5 x 12,5	2500	2, 4	3m 3-adrig 1,5 mm ² , Schuko-stecker	1/N/PE ~ 230 V 50 Hz
1 x 2,0 kW	Diepzwart	URCAC200V9005	4260051486246	IP67	61 x 9,5 x 12,5	2500	2, 4	3m 3-adrig 1,5 mm ² , Schuko-stecker	1/N/PE ~ 230 V 50 Hz



TERM 2000 COLOR IP67 (610 mm) HIRSCHMANN

1 x 1,50 kW	Zuiver wit	URCAC150VH9010	4260051485805	IP67	61 x 9,5 x 12,5	2500	2, 4	3m 3-adrig 1,5 mm ² , Schuko-stecker	1/N/PE ~ 230 V 50 Hz
1 x 1,65 kW	Zuiver wit	URCAC165VH9010	4260051485812	IP67	61 x 9,5 x 12,5	2500	2, 4	3m 3-adrig 1,5 mm ² , Schuko-stecker	1/N/PE ~ 230 V 50 Hz
1 x 2,0 kW	Zuiver wit	URCAC200VH9010	4260051485829	IP67	61 x 9,5 x 12,5	2500	2, 4	3m 3-adrig 1,5 mm ² , Schuko-stecker	1/N/PE ~ 230 V 50 Hz
1 x 1,5 kW	Diepzwart	URCAC150VH9005	4260051486307	IP67	61 x 9,5 x 12,5	2500	2, 4	3m 3-adrig 1,5 mm ² , Schuko-stecker	1/N/PE ~ 230 V 50 Hz
1 x 1,65 kW	Diepzwart	URCAC165VH9005	4260051486314	IP67	61 x 9,5 x 12,5	2500	2, 4	3m 3-adrig 1,5 mm ² , Schuko-stecker	1/N/PE ~ 230 V 50 Hz
1 x 2,0 kW	Diepzwart	URCAC200VH9005	4260051486321	IP67	61 x 9,5 x 12,5	2500	2, 4	3m 3-adrig 1,5 mm ² , Schuko-stecker	1/N/PE ~ 230 V 50 Hz



TERM 2000 COLOR S IP67 (464 mm)

1 x 1,70 kW	Zuiver wit	RCACS170V9010	4260051485836	IP67	46,4 x 9,5 x 12,5	2100	2, 4	3m 3-adrig 1,5 mm ² , Schuko-stecker	1/N/PE ~ 230 V 50 Hz
1 x 2,0 kW	Zuiver wit	RCACS200V9010	4260051485843	IP67	46,4 x 9,5 x 12,5	2100	2, 4	3m 3-adrig 1,5 mm ² , Schuko-stecker	1/N/PE ~ 230 V 50 Hz
1 x 1,7 kW	Diepzwart	RCACS170V9005	4260051486253	IP67	46,4 x 9,5 x 12,5	2100	2, 4	3m 3-adrig 1,5 mm ² , Schuko-stecker	1/N/PE ~ 230 V 50 Hz
1 x 2,0 kW	Diepzwart	RCACS200V9005	4260051486260	IP67	46,4 x 9,5 x 12,5	2100	2, 4	3m 3-adrig 1,5 mm ² , Schuko-stecker	1/N/PE ~ 230 V 50 Hz



TERM 2000 MULTI

2 x 1,65 kW	Aluminium gepolijst	RCJ330	4260051480435	IP67	132,5 x 9,5 x 12,5	4900	4	1m 5-adrig 1,5 mm ² , Adereindhulzen	2/N/PE ~ 400 (2N) V 50Hz
2 x 1,65 kW	Aluminium gepolijst	PCRCJ330	4260051481975	IP67	132 x 9,5 x 12,5	4900	1, 4	1m 5-adrig 1,5 mm ² , Adereindhulzen	2/N/PE ~ 400 (2N) V 50Hz
2 x 2,0 kW	Aluminium gepolijst	RCJ400V	4260051480442	IP67	132,5 x 9,5 x 12,5	4900	4	1m 5-adrig 1,5 mm ² , Adereindhulzen	2/N/PE ~ 400 (2N) V 50Hz

UITRUSTING:

1 = PERFECTCLIME

2 = LOW GLARE  (100% warmte bij 80% minder licht!)

3 = NO GLARE  (100% lichtreductie!)

4 = Waterdicht 

5 = Licht 

VERMOGEN	MATERIAAL	CODE	EAN	IP AANDUIDING	AFMETINGEN (B x H x T in cm)	GEWICHT (in g)	UITRUSTING	SNOERLENGTE	STROOMA ANSLUITING
2 x 2,0 kW	Aluminium gepolijst	PCRCJ400V	4260051481838	IP67	132 x 9,5 x 12,5	4900	1, 4	1m 5-adrig 1,5 mm ² , Adereindhulzen	2/N/PE ~ 400 (2N) V 50Hz
2 x 1,65 kW	Aluminium gepolijst	URCJ330V	4260051483870	IP67	132 x 9,5 x 12,5	4900	2, 4	1m 5-adrig 1,5 mm ² , Adereindhulzen	2/N/PE ~ 400 (2N) V 50Hz
2 x 1,65 kW	Aluminium gepolijst	UPCRCJ330V	4260051484518	IP67	132,5 x 9,5 x 12,5	4900	1, 2, 4	1m 5-adrig 1,5 mm ² , Adereindhulzen	2/N/PE ~ 400 (2N) V 50Hz
2 x 2,0 kW	Aluminium gepolijst	URCJ400V	4260051483887	IP67	132 x 9,5 x 12,5	4900	2, 4	1m 5-adrig 1,5 mm ² , Adereindhulzen	2/N/PE ~ 400 (2N) V 50Hz
2 x 2,0 kW	Aluminium gepolijst	UPCRCJ400V	4260051484525	IP67	132,5 x 9,5 x 12,5	4900	1, 2, 4	1m 5-adrig 1,5 mm ² , Adereindhulzen	2/N/PE ~ 400 (2N) V 50Hz
3 x 1,65 kW	Aluminium gepolijst	RCC495	4260051480459	IP67	60 x 29 x 12,5	6800	4	1m 5-adrig 2,5mm ² , Adereindhulzen	2/N/PE ~ 400 (2N) V 50Hz
3 x 2,0 kW	Aluminium gepolijst	RCC600V	4260051480466	IP67	60 x 29 x 12,5	6800	4	1m 5-adrig 2,5mm ² , Adereindhulzen	2/N/PE ~ 400 (2N) V 50Hz
3 x 1,65 kW	Aluminium gepolijst	URCC495V	4260051483894	IP67	60 x 29 x 12,5	6800	2, 4	1m 5-adrig 2,5mm ² , Adereindhulzen	2/N/PE ~ 400 (2N) V 50Hz
3 x 2,0 kW	Aluminium gepolijst	URCC600V	4260051483900	IP67	60 x 29 x 12,5	6800	2, 4	1m 5-adrig 2,5mm ² , Adereindhulzen	2/N/PE ~ 400 (2N) V 50Hz



TERM 2000 IP24 LOW GLARE

1 x 1,5 kW	Aluminium gepolijst	URCA01524V	4260051484082	IP24	51 x 9,5 x 12,5	2300	2	3m 3-adrig 1,5 mm ² , Schuko-stecker	1/N/PE ~ 230 V 50 Hz
1 x 2,0 kW	Aluminium gepolijst	URCA02024V	4260051484099	IP24	51 x 9,5 x 12,5	2300	2	3m 3-adrig 1,5 mm ² , Schuko-stecker	1/N/PE ~ 230 V 50 Hz



TERM 2000 IP20 NO GLARE

1 x 1,0 kW	Aluminium gepolijst	NRCA100	4260051485874	IP20	41 x 9,5 x 12,5	2100	3	3m 3-adrig 1,5 mm ² , Schuko-stecker	1/N/PE ~ 230 V 50 Hz
1 x 1,0 kW	Zwart	NRCA100-1	4260051485881	IP20	41 x 9,5 x 12,5	2100	3	3m 3-adrig 1,5 mm ² , Schuko-stecker	1/N/PE ~ 230 V 50 Hz



TERM 2000 IP65 L&H

1,0 + 0,10 kW	Aluminium gepolijst	RLH1165	4260051482781	IP65	82,5 x 9,5 x 12,5	3350	4, 5	2m 5-adrig 1,5mm ² , Adereindhulzen	1/N/PE ~ 230 V 50 Hz
1,0 + 0,10 kW	Aluminium gepolijst	PCRLH1165	4260051481982	IP65	91 x 9,5 x 12,5	4050	1, 4, 5	2m 5-adrig 1,5mm ² , Adereindhulzen	1/N/PE ~ 230 V 50 Hz
1,65 + 0,10 kW	Aluminium gepolijst	RLH1765	4260051482798	IP65	82,5 x 9,5 x 12,5	3350	4, 5	2m 5-adrig 1,5mm ² , Adereindhulzen	1/N/PE ~ 230 V 50 Hz
1,65 + 0,10 kW	Aluminium gepolijst	PCRLH1765	4260051481999	IP65	91 x 9,5 x 12,5	4050	1, 4, 5	2m 5-adrig 1,5mm ² , Adereindhulzen	1/N/PE ~ 230 V 50 Hz
2,0 + 0,10 kW	Aluminium gepolijst	RLH2165	4260051482804	IP65	82,5 x 9,5 x 12,5	3350	4, 5	2m 5-adrig 1,5mm ² , Adereindhulzen	1/N/PE ~ 230 V 50 Hz
2,0+ 0,10 kW	Aluminium gepolijst	PCRLH2165	4260051481685	IP65	91 x 9,5 x 12,5	4050	1, 4, 5	2m 5-adrig 1,5mm ² , Adereindhulzen	1/N/PE ~ 230 V 50 Hz
1,65 + 0,10 kW	Aluminium gepolijst	UPCRLH1165	4260051484549	IP65	91 x 9,5 x 12,5	4050	1, 2, 4, 5	2m 5-adrig 1,5mm ² , Adereindhulzen	1/N/PE ~ 230 V 50 Hz
1,65 + 0,10 kW	Aluminium gepolijst	URLH1765	4260051484020	IP65	82,5 x 9,5 x 12,5	3350	2, 4, 5	2m 5-adrig 1,5mm ² , Adereindhulzen	1/N/PE ~ 230 V 50 Hz
1,65 + 0,10 kW	Aluminium gepolijst	UPCRLH1765	4260051484556	IP65	91 x 9,5 x 12,5	4050	1, 2, 4, 5	2m 5-adrig 1,5mm ² , Adereindhulzen	1/N/PE ~ 230 V 50 Hz
2,0 + 0,10 kW	Aluminium gepolijst	URLH2165	4260051484037	IP65	82,5 x 9,5 x 12,5	3350	2, 4, 5	2m 5-adrig 1,5mm ² , Adereindhulzen	1/N/PE ~ 230 V 50 Hz
2,0 + 0,10 kW	Aluminium gepolijst	UPCRLH2165	4260051484570	IP65	91 x 9,5 x 12,5	4050	1, 2, 4, 5	2m 5-adrig 1,5mm ² , Adereindhulzen	1/N/PE ~ 230 V 50 Hz
1,0 + 0,10 kW	Aluminium gepolijst	RLH1165F	4260051483382	IP65	78 x 9,5 x 12,5	3350	4, 5	2m 5-adrig 1,5mm ² , Adereindhulzen	1/N/PE ~ 230 V 50 Hz
1,0 + 0,10 kW	Aluminium gepolijst	PCRLH1165F	4260051485140	IP65	87 x 9,5 x 12,5	4050	1, 4, 5	2m 5-adrig 1,5mm ² , Adereindhulzen	1/N/PE ~ 230 V 50 Hz
1,65 + 0,10 kW	Aluminium gepolijst	RLH1765F	4260051483467	IP65	78 x 9,5 x 12,5	3350	4, 5	2m 5-adrig 1,5mm ² , Adereindhulzen	1/N/PE ~ 230 V 50 Hz
1,65 + 0,10 kW	Aluminium gepolijst	PCRLH1765F	4260051483467	IP65	87 x 9,5 x 12,5	4050	1, 4, 5	2m 5-adrig 1,5mm ² , Adereindhulzen	1/N/PE ~ 230 V 50 Hz

VERMOGEN	MATERIAAL	CODE	EAN	IP AANDUIDING	AFMETINGEN (B x H x T in cm)	GEWICHT (in g)	UITRUSTING	SNOERLENGTE	STROOMA ANSLUITING
2,0 + 0,10 kW	Aluminium gepolijst	RLH2165F	4260051483474	IP65	78 x 9,5 x 12,5	3350	4, 5	2m 5-adrig 1,5mm ² , Adereindhulzen	1/N/PE ~ 230 V 50 Hz
2,0 + 0,10 kW	Aluminium gepolijst	PCRLH2165F	4260051483474	IP65	87 x 9,5 x 12,5	4050	1, 4, 5	2m 5-adrig 1,5mm ² , Adereindhulzen	1/N/PE ~ 230 V 50 Hz
1,65 + 0,10 kW	Aluminium gepolijst	UPCRLH1165F	4260051485676	IP65	87 x 9,5 x 12,5	4050	1, 2, 4, 5	2m 5-adrig 1,5mm ² , Adereindhulzen	1/N/PE ~ 230 V 50 Hz
1,65 + 0,10 kW	Aluminium gepolijst	URLH1765F	4260051484044	IP65	78 x 9,5 x 12,5	3350	2, 4, 5	2m 5-adrig 1,5mm ² , Adereindhulzen	1/N/PE ~ 230 V 50 Hz
1,65 + 0,10 kW	Aluminium gepolijst	UPCRLH1765F	4260051484563	IP65	87 x 9,5 x 12,5	4050	1, 2, 4, 5	2m 5-adrig 1,5mm ² , Adereindhulzen	1/N/PE ~ 230 V 50 Hz
2,0 + 0,10 kW	Aluminium gepolijst	URLH2165F	4260051484051	IP65	78 x 9,5 x 12,5	3350	2, 4, 5	2m 5-adrig 1,5mm ² , Adereindhulzen	1/N/PE ~ 230 V 50 Hz
2,0 + 0,10 kW	Aluminium gepolijst	UPCRLH2165F	4260051484594	IP65	87 x 9,5 x 12,5	4050	1, 2, 4, 5	2m 5-adrig 1,5mm ² , Adereindhulzen	1/N/PE ~ 230 V 50 Hz



TERM 2000 IP65 L&H (191 cm)

2 x 1,0 + 0,20 kW	Aluminium gepolijst	RLH2265	4260051482002	IP65	191 x 9,5 x 12,5	7100	4, 5	2m 5-adrig 2,5mm ² , Adereindhulzen	1/N/PE ~ 235V 50 Hz
2 x 1,0 + 0,20 kW	Aluminium gepolijst	PCRLH2265	4260051482002	IP65	200 x 9,5 x 12,5	7700	1, 4, 5	2m 5-adrig 2,5mm ² , Adereindhulzen	1/N/PE ~ 235 V 50 Hz
2 x 1,65 + 0,20 kW	Aluminium gepolijst	RLH3565	4260051482057	IP65	191 x 9,5 x 12,5	7100	4, 5	2m 5-adrig 2,5mm ² , Adereindhulzen	1/N/PE ~ 235 V 50 Hz
2 x 1,65 + 0,20 kW	Aluminium gepolijst	PCRLH3565	4260051482057	IP65	200 x 9,5 x 12,5	7700	1, 4, 5	2m 5-adrig 2,5mm ² , Adereindhulzen	1/N/PE ~ 235 V 50 Hz
2 x 2,0 + 4 x 50 W	Aluminium gepolijst	RLH4265	4260051481852	IP65	191 x 9,5 x 12,5	7100	4, 5	2m 5-adrig 2,5mm ² , Adereindhulzen	1/N/PE ~ 235 V 50 Hz
2 x 2,0 + 0,20 kW	Aluminium gepolijst	PCRLH4265	4260051481852	IP65	200 x 9,5 x 12,5	7700	1, 4, 5	2m 5-adrig 2,5mm ² , Adereindhulzen	1/N/PE ~ 235 V 50 Hz
2 x 1,0 + 0,20 kW	Aluminium gepolijst	UPCRLH2265	4260051484600	IP65	200 x 9,5 x 12,5	7700	1, 2, 4, 5	2m 5-adrig 2,5mm ² , Adereindhulzen	1/N/PE ~ 235 V 50 Hz
2 x 1,65 + 0,20 kW	Aluminium gepolijst	URLH3565	4260051484068	IP65	191 x 9,5 x 12,5	7100	2, 4, 5	2m 5-adrig 2,5mm ² , Adereindhulzen	1/N/PE ~ 235 V 50 Hz
2 x 1,65 + 0,20 kW	Aluminium gepolijst	UPCRLH3565	4260051484617	IP65	200 x 9,5 x 12,5	7700	1, 2, 4, 5	2m 5-adrig 2,5mm ² , Adereindhulzen	1/N/PE ~ 235 V 50 Hz
2 x 2,0 + 0,20 kW	Aluminium gepolijst	URLH4265	4260051484075	IP65	191 x 9,5 x 12,5	7100	2, 4, 5	2m 5-adrig 2,5mm ² , Adereindhulzen	1/N/PE ~ 235 V 50 Hz
2 x 2,0 + 0,20 kW	Aluminium gepolijst	UPCRLH4265	4260051484624	IP65	200 x 9,5 x 12,5	7700	1, 2, 4, 5	2m 5-adrig 2,5mm ² , Adereindhulzen	1/N/PE ~ 235 V 50 Hz



TERM 2000 IP65 LIGHT SYSTEMS

1 x 50 W	Aluminium gepolijst	RL1	4260051485638	IP65	25 x 9,5 x 12,5	1800	5	3m 3-adrig 1,5 mm ² , Schukostecker	1/N/PE ~ 230 V 50 Hz
2 x 50 W	Aluminium gepolijst	RL2	4260051485645	IP65	49 x 9,5 x 12,5	2500	5	3m 3-adrig 1,5 mm ² , Schukostecker	1/N/PE ~ 230 V 50 Hz
3 x 50 W	Aluminium gepolijst	RL3	4260051485652	IP65	73 x 9,5 x 12,5	3500	5	3m 3-adrig 1,5 mm ² , Schukostecker	1/N/PE ~ 230 V 50 Hz
4 x 50 W	Aluminium gepolijst	RL4	4260051485669	IP65	97 x 9,5 x 12,5	4300	5	3m 3-adrig 1,5 mm ² , Schukostecker	1/N/PE ~ 230 V 50 Hz
1 x 50 W	Zuiver wit	RL1C9010	4260051485676	IP65	25 x 9,5 x 12,5	1800	5	3m 3-adrig 1,5 mm ² , Schukostecker	1/N/PE ~ 230 V 50 Hz
2 x 50 W	Zuiver wit	RL2C9010	4260051485683	IP65	49 x 9,5 x 12,5	2500	5	3m 3-adrig 1,5 mm ² , Schukostecker	1/N/PE ~ 230 V 50 Hz
3 x 50 W	Zuiver wit	RL3C9010	4260051485690	IP65	73 x 9,5 x 12,5	3500	5	3m 3-adrig 1,5 mm ² , Schukostecker	1/N/PE ~ 230 V 50 Hz
4 x 50 W	Zuiver wit	RL4C9010	4260051485706	IP65	97 x 9,5 x 12,5	4300	5	3m 3-adrig 1,5 mm ² , Schukostecker	1/N/PE ~ 230 V 50 Hz
1 x 50 W	Diepzwart	RL1C9005	4260051486338	IP65	25 x 9,5 x 12,5	1800	5	3m 3-adrig 1,5 mm ² , Schukostecker	1/N/PE ~ 230 V 50 Hz
2 x 50 W	Diepzwart	RL2C9005	4260051486345	IP65	49 x 9,5 x 12,5	2500	5	3m 3-adrig 1,5 mm ² , Schukostecker	1/N/PE ~ 230 V 50 Hz
3 x 50 W	Diepzwart	RL3C9005	4260051486352	IP65	73 x 9,5 x 12,5	3500	5	3m 3-adrig 1,5 mm ² , Schukostecker	1/N/PE ~ 230 V 50 Hz
4 x 50 W	Diepzwart	RL4C9005	4260051486369	IP65	97 x 9,5 x 12,5	4300	5	3m 3-adrig 1,5 mm ² , Schukostecker	1/N/PE ~ 230 V 50 Hz

UITRUSTING:

1 = PERFECTCLIME

2 = LOW GLARE  (100% warmte bij 80% minder licht!)

3 = NO GLARE  (100% lichtreductie!)

4 = Waterdicht 

5 = Licht 



TERM TOWER PALMS

2 x 2,0 kW	Aluminium gepolijst	RTT400V	4260051482941	IP67	110 x 250-270	ca. 45000	4	10m 5-adrig 2,5mm ² , Adereindhulzen	3/N/PE ~ 400 (3N)V 50 Hz
2 x 2,0 kW	Aluminium gepolijst	PCRTT400V	4260051482064	IP67	110 x 250-270	ca. 45000	1, 4	10m 5-adrig 2,5mm ² , Adereindhulzen	3/N/PE ~ 400 (3N)V 50 Hz
3 x 2,0 kW	Aluminium gepolijst	RTT600V	4260051482958	IP67	110 x 250-270	ca. 45000	4	10m 5-adrig 2,5mm ² , Adereindhulzen	3/N/PE ~ 400 (3N)V 50 Hz
3 x 2,0 kW	Aluminium gepolijst	PCRTT600V	4260051481869	IP67	110 x 250-270	ca. 45000	1, 4	10m 5-adrig 2,5mm ² , Adereindhulzen	3/N/PE ~ 400 (3N)V 50 Hz
4 x 2,0 kW	Aluminium gepolijst	RTT800V	4260051482965	IP67	110 x 250-270	ca. 45000	4	10m 5-adrig 2,5mm ² , Adereindhulzen	3/N/PE ~ 400 (3N)V 50 Hz
4 x 2,0 kW	Aluminium gepolijst	PCRTT800V	4260051482071	IP67	110 x 250-270	ca. 45000	1, 4	10m 5-adrig 2,5mm ² , Adereindhulzen	3/N/PE ~ 400 (3N)V 50 Hz
2 x 2,0 kW	Aluminium gepolijst	URTT400V	4260051483917	IP67	110 x 250-270	ca. 45000	2, 4	10m 5-adrig 2,5mm ² , Adereindhulzen	3/N/PE ~ 400 (3N)V 50 Hz
2 x 2,0 kW	Aluminium gepolijst	UPCRTT400V	4260051484631	IP67	110 x 250-270	ca. 45000	1, 2, 4	10m 5-adrig 2,5mm ² , Adereindhulzen	3/N/PE ~ 400 (3N)V 50 Hz
3 x 2,0 kW	Aluminium gepolijst	URTT600V	4260051483924	IP67	110 x 250-270	ca. 45000	2, 4	10m 5-adrig 2,5mm ² , Adereindhulzen	3/N/PE ~ 400 (3N)V 50 Hz
3 x 2,0 kW	Aluminium gepolijst	UPCRTT600V	4260051484648	IP67	110 x 250-270	ca. 45000	1, 2, 4	10m 5-adrig 2,5mm ² , Adereindhulzen	3/N/PE ~ 400 (3N)V 50 Hz
4 x 2,0 kW	Aluminium gepolijst	URTT800V	4260051483931	IP67	110 x 250-270	ca. 45000	2, 4	10m 5-adrig 2,5mm ² , Adereindhulzen	3/N/PE ~ 400 (3N)V 50 Hz
4 x 2,0 kW	Aluminium gepolijst	UPCRTT800V	4260051484365	IP67	110 x 250-270	ca. 45000	1, 2, 4	10m 5-adrig 2,5mm ² , Adereindhulzen	3/N/PE ~ 400 (3N)V 50 Hz



TERM TOWER

3 x 1,0 kW	Aluminium gepolijst	RTT030	4260051480558	IP24	110 x 250-270	ca. 45000		10m 5-adrig 2,5mm ² , Adereindhulzen	3/N/PE ~ 400 (3N) V 50 Hz
3 x 1,5 kW	Aluminium gepolijst	RTT045	4260051482811	IP24	110 x 250-270	ca. 45000		10m 5-adrig 2,5mm ² , Adereindhulzen	3/N/PE ~ 400 (3N) V 50 Hz
3 x 2,0 kW	Aluminium gepolijst	RTT060	4260051482828	IP24	110 x 250-270	ca. 45000		10m 5-adrig 2,5mm ² , Adereindhulzen	3/N/PE ~ 400 (3N) V 50 Hz
3 x 1,5 kW	Aluminium gepolijst	URTT045	4260051483948	IP24	110 x 250-270	ca. 45000	2	10m 5-adrig 2,5mm ² , Adereindhulzen	3/N/PE ~ 400 (3N) V 50 Hz
3 x 2,0 kW	Aluminium gepolijst	URTT060	4260051483955	IP24	110 x 250-270	ca. 45000	2	10m 5-adrig 2,5mm ² , Adereindhulzen	3/N/PE ~ 400 (3N) V 50 Hz
TERM TOWER KIT 250 cm		RTTK250*	4260051482934	IP65	110 x 250-270				



TERM TOWER TISCH

TERM TOWER TISCH/ TABLE	RTTT	4260051480589
TERM TOWER ASHTRAY/ASCHER	RTTA	4260051480596



TERM TOWER HANGING HORIZONTAL IP67/L&H IP65

3 x 2,0 kW	Aluminium gepolijst	RTTHH600V	4260051483542	IP67	110 x 250-270	ca. 45000	4	10m 5-adrig, 2,5mm ² , Adereindhulzen	3/N/PE ~ 400 (3N) V 50 Hz
3 x 2,0 kW	Aluminium gepolijst	PCRTTHH600V	4260051484792	IP67	110 x 250-270	ca. 45000	1, 4	10m 5-adrig, 2,5mm ² , Adereindhulzen	3/N/PE ~ 400 (3N) V 50 Hz
3 x 2,0 kW	Aluminium gepolijst	PCRTTHH600V2	4260051485133	IP67	110 x 250-270	ca. 45000	1, 4	10m 5-adrig, 2,5mm ² , Adereindhulzen	3/N/PE ~ 400 (3N) V 50 Hz
3 x 2,0 kW	Aluminium gepolijst	RTTHHLH3F	4260051483511	IP65	110 x 250-270	ca. 45000	1, 4, 5	10m 5-adrig, 2,5mm ² , Adereindhulzen	3/N/PE ~ 400 (3N) V 50 Hz
3 x 2,0 kW	Aluminium gepolijst	PCRTTHHLH3F	4260051484815	IP65	110 x 250-270	ca. 45000	1, 4, 5	10m 5-adrig, 2,5mm ² , Adereindhulzen	3/N/PE ~ 400 (3N) V 50 Hz
3 x 2,0 kW	Aluminium gepolijst	RTTHHLH3	4260051483528	IP65	110 x 250-270	ca. 45000	4, 5	10m 5-adrig, 2,5mm ² , Adereindhulzen	3/N/PE ~ 400 (3N) V 50 Hz
3 x 2,0 kW	Aluminium gepolijst	PCRTTHHLH3	4260051484808	IP65	110 x 250-270	ca. 45000	1, 4, 5	10m 5-adrig, 2,5mm ² , Adereindhulzen	3/N/PE ~ 400 (3N) V 50 Hz
3 x 2,0 kW	Aluminium gepolijst	URTHH600V	4260051483962	IP67	110 x 250-270	ca. 45000	2, 4	10m 5-adrig, 2,5mm ² , Adereindhulzen	3/N/PE ~ 400 (3N) V 50 Hz
3 x 2,0 kW	Aluminium gepolijst	UPCRTTHH600V	4260051484952	IP67	110 x 250-270	ca. 45000	1, 2, 4	10m 5-adrig, 2,5mm ² , Adereindhulzen	3/N/PE ~ 400 (3N) V 50 Hz
3 x 2,0 kW	Aluminium gepolijst	URTHHLH3F	4260051483979	IP65	110 x 250-270	ca. 45000	2, 4, 5	10m 5-adrig, 2,5mm ² , Adereindhulzen	3/N/PE ~ 400 (3N) V 50 Hz
3 x 2,0 kW	Aluminium gepolijst	UPCRTTHHLH3F	4260051484976	IP65	110 x 250-270	ca. 45000	1, 2, 4, 5	10m 5-adrig, 2,5mm ² , Adereindhulzen	3/N/PE ~ 400 (3N) V 50 Hz
3 x 2,0 kW	Aluminium gepolijst	URTHHLH3	4260051483986	IP65	110 x 250-270	ca. 45000	2, 4, 5	10m 5-adrig, 2,5mm ² , Adereindhulzen	3/N/PE ~ 400 (3N) V 50 Hz
3 x 2,0 kW	Aluminium gepolijst	UPCRTTHHLH3	4260051484969	IP65	110 x 250-270	ca. 45000	1, 2, 4, 5	10m 5-adrig, 2,5mm ² , Adereindhulzen	3/N/PE ~ 400 (3N) V 50 Hz



TERM TOWER HANGING VERTICAL IP67

3 x 2,0 kW	Aluminium gepolijst	RTTH600V	4260051483535	IP67	110 x 250-270	ca. 45000	4	10m 5-adrig, 2,5mm ² , Adereindhulzen	3/N/PE ~ 400 (3N) V 50 Hz
3 x 2,0 kW	Aluminium gepolijst	PCRTTH600V	4260051484822	IP67	110 x 250-270	ca. 45000	1, 4	10m 5-adrig, 2,5mm ² , Adereindhulzen	3/N/PE ~ 400 (3N) V 50 Hz
3 x 2,0 kW	Aluminium gepolijst	URTH600V	4260051483993	IP67	110 x 250-270	ca. 45000	2, 4	10m 5-adrig, 2,5mm ² , Adereindhulzen	3/N/PE ~ 400 (3N) V 50 Hz
3 x 2,0 kW	Aluminium gepolijst	UPCRTTH600V	4260051484983	IP67	110 x 250-270	ca. 45000	1, 2, 4	10m 5-adrig, 2,5mm ² , Adereindhulzen	3/N/PE ~ 400 (3N) V 50 Hz



TERM TOWER HANGING IP24

3 x 1,0 kW	Aluminium gepolijst	RTTH030	4260051483481	IP24	110 x 250-270	ca. 45000		10m 5-adrig, 2,5mm ² , Adereindhulzen	3/N/PE ~ 400 (3N) V 50 Hz
3 x 1,5 kW	Aluminium gepolijst	RTTH045	4260051483498	IP24	110 x 250-270	ca. 45000		10m 5-adrig, 2,5mm ² , Adereindhulzen	3/N/PE ~ 400 (3N) V 50 Hz
3 x 2,0 kW	Aluminium gepolijst	RTTH060	4260051483504	IP24	110 x 250-270	ca. 45000		10m 5-adrig, 2,5mm ² , Adereindhulzen	3/N/PE ~ 400 (3N) V 50 Hz
3 x 1,5 kW	Aluminium gepolijst	URTH045	4260051484006	IP24	110 x 250-270	ca. 45000	2	10m 5-adrig, 2,5mm ² , Adereindhulzen	3/N/PE ~ 400 (3N) V 50 Hz
3 x 2,0 kW	Aluminium gepolijst	URTH060	4260051484013	IP24	110 x 250-270	ca. 45000	2	10m 5-adrig, 2,5mm ² , Adereindhulzen	3/N/PE ~ 400 (3N) V 50 Hz



TERM IR SPA IP20

1 x 0,5 kW	Zilver	IRSPA50	4260051482996	IP20	9,5 x 87,5 x 12,5	2.500 g		3m 3-adrig 1,5 mm ² , Schukostecker	1/N/PE ~ 230 V 50 Hz
1 x 0,75 kW	Zilver	IRSPA75	4260051483009	IP20	9,5 x 87,5 x 12,5	2.500 g		3m 3-adrig 1,5 mm ² , Schukostecker	1/N/PE ~ 230 V 50 Hz



TERM 2000 CVH IP20

1 x 1,5 kW	Zwart	RCAC015VH-1	4260051482194	IP20	42,5 x 15 x 21	1500		3m 3-adrig 1,5 mm ² , Schukostecker	1/N/PE ~ 230 V 50 Hz
1 x 1,5 kW	Rood	RCAC015VH-4	4260051482200	IP20	42,5 x 15 x 21	1500		3m 3-adrig 1,5 mm ² , Schukostecker	1/N/PE ~ 230 V 50 Hz
1 x 2,0 kW	Zwart	RCAC020VH-1	4260051482293	IP20	42,5 x 15 x 21	1500		3m 3-adrig 1,5 mm ² , Schukostecker	1/N/PE ~ 230 V 50 Hz
1 x 2,0 kW	Rood	RCAC020VH-4	4260051482309	IP20	42,5 x 15 x 21	1500		3m 3-adrig 1,5 mm ² , Schukostecker	1/N/PE ~ 230 V 50 Hz



TERM 2500 VOLCANO IP20

1 x 1,5 kW	Zwart	RC V 025	4260051482507	IP20	41 x 52 x 31	5450		3m 3-adrig 1,5 mm ² , Schukostecker	1/N/PE ~ 230 V 50 Hz
------------	-------	----------	---------------	------	--------------	------	--	--	-------------------------



SMART TOWER DIMMER IP20

2 x 1,5 kW	Zwart	BHST30-1	4260051487175	IP20	29 x 126 x 32	7300	2	3m 3-adrig 1,5 mm ² , Schukostecker	1/N/PE ~ 230 V 50Hz
2 x 1,5 kW	Wit	BHST30-2	4260051487182	IP20	29 x 126 x 32	7300	2	3m 3-adrig 1,5 mm ² , Schukostecker	1/N/PE ~ 230 V 50 Hz

VERMOGEN	MATERIAAL	CODE	EAN	IP AANDUIDING	AFMETINGEN (B x H x T in cm)	GEWICHT (in g)	UITRUSTING	SNOERLENGTE	STROOMA ANSLUITING
2 x 1,5 kW	Zilver	BHST30-3	4260051487199	IP20	29 x 126 x 32	7300	2	3m 3-adrig 1,5 mm ² , Schukostecker	1/N/PE ~ 230 V 50 Hz
2 x 1,5 kW	Rood	BHST30-4	4260051487205	IP20	29 x 126 x 32	7300	2	3m 3-adrig 1,5 mm ² , Schukostecker	1/N/PE ~ 230 V 50 Hz



SMART IP20

1 x 0,8 kW	Wit	BHS08	4260051487137	IP20	31 x 14,5 x 9,5	1900	2	3m 3-adrig 1,5 mm ² , Schukostecker	1/N/PE ~ 230 V 50 Hz
1 x 1,3 kW	Wit	BHS13	4260051487113	IP20	31 x 14,5 x 9,5	1900	2	3m 3-adrig 1,5 mm ² , Schukostecker	1/N/PE ~ 230 V 50 Hz
1 x 1,5 kW	Wit	BHS15	4260051487014	IP20	40,5 x 14,5 x 9,5	2200	2	3m 3-adrig 1,5 mm ² , Schukostecker	1/N/PE ~ 230 V 50 Hz
1 x 1,5 kW	Zilver	BHS15-3	4260051487045	IP20	40,5 x 14,5 x 9,5	2200	2	3m 3-adrig 1,5 mm ² , Schukostecker	1/N/PE ~ 230 V 50 Hz
1 x 2,0 kW	Wit	BHS20	4260051487021	IP20	40,5 x 14,5 x 9,5	2200	2	3m 3-adrig 1,5 mm ² , Schukostecker	1/N/PE ~ 230 V 50 Hz
1 x 2,0 kW	Zilver	BHS20-3	4260051487052	IP20	40,5 x 14,5 x 9,5	2200	2	3m 3-adrig 1,5 mm ² , Schukostecker	1/N/PE ~ 230 V 50 Hz
1 x 2,0 kW	Zwart	BHS20-1	4260051487236	IP20	40,5 x 14,5 x 9,5	2200	2	3m 3-adrig 1,5 mm ² , Schukostecker	1/N/PE ~ 230 V 50 Hz

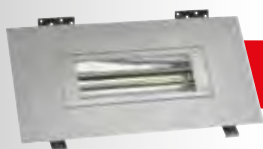

SMART FRAME IP20

1 x 1,5 kW	Wit	BHSF15-2	4260051487304	IP20	60 x 32,5 x 10	4900	2	3m 3-adrig 1,5 mm ² , Schukostecker	1/N/PE ~ 230 V 50 Hz
1 x 1,5 kW	Zilver	BHSF15-3	4260051487311	IP20	60 x 32,5 x 10	4900	2	3m 3-adrig 1,5 mm ² , Schukostecker	1/N/PE ~ 230 V 50 Hz
1 x 2,0 kW	Wit	BHSF20-2	4260051487328	IP20	60 x 32,5 x 10	4900	2	3m 3-adrig 1,5 mm ² , Schukostecker	1/N/PE ~ 230 V 50 Hz
2,0 kW	Zilver	BHSF20-3	4260051487335	IP20	60 x 32,5 x 10	4900	2	3m 3-adrig 1,5 mm ² , Schukostecker	1/N/PE ~ 230 V 50 Hz



SMART IP24

1 x 1,5 kW	Wit	BHS1524	4260051489568	IP24	48 x 14,5 x 9,5	2500	2	3m 3-adrig 1,5 mm ² , Schukostecker	1/N/PE ~ 230 V 50 Hz
1 x 1,5 kW	Wit	PCBHS1524	4260051485034	IP24	55,5 x 14,5 x 9,5	2500	1,2	3m 3-adrig 1,5 mm ² , Schukostecker	1/N/PE ~ 230 V 50 Hz
1 x 1,5 kW	Wit	PCBHS15242	4260051486536	IP24	63 x 14,5 x 9,5	2500	1,2	3m 3-adrig 1,5 mm ² , Schukostecker	1/N/PE ~ 230 V 50 Hz
1 x 1,5 kW	Zilver	BHS1524-3	4260051489551	IP24	48 x 14,5 x 9,5	2500	2	3m 3-adrig 1,5 mm ² , Schukostecker	1/N/PE ~ 230 V 50 Hz
1 x 2,0 kW	Wit	BHS2024	4260051489575	IP24	55,5 x 14,5 x 9,5	2500	2	3m 3-adrig 1,5 mm ² , Schukostecker	1/N/PE ~ 230 V 50 Hz
1 x 2,0 kW	Wit	PCBHS2024	4260051485041	IP24	63 x 14,5 x 9,5	2500	1,2	3m 3-adrig 1,5 mm ² , Schukostecker	1/N/PE ~ 230 V 50 Hz
1 x 2,0 kW	Wit	PCBHS20242	4260051486543	IP24	63 x 14,5 x 9,5	2500	1,2	3m 3-adrig 1,5 mm ² , Schukostecker	1/N/PE ~ 230 V 50 Hz
1 x 2,0 kW	Zilver	BHS2024-3	4260051489582	IP24	48 x 14,5 x 9,5	2500	2	3m 3-adrig 1,5 mm ² , Schukostecker	1/N/PE ~ 230 V 50 Hz
1 x 2,0 kW	Zwart	BHS2024-1	4260051480053	IP24	48 x 14,5 x 9,5	2500	2	3m 3-adrig 1,5 mm ² , Schukostecker	1/N/PE ~ 230 V 50 Hz



SMART IP24 MULTI

2 x 1,5 kW	Wit	BHS3024	4260051487243	IP24	89,5 x 14,5 x 9,5	4000	2	3m 5-adrig 2,5mm ² , Adereindhulzen	3/N/PE ~ 400 (3N) V 50 Hz
2 x 1,5 kW	Wit	PCBHS30242	4260051485065	IP24	111,5 x 14,5 x 9,5	4000	1,2	3m 5-adrig 2,5mm ² , Adereindhulzen	3/N/PE ~ 400 (3N) V 50 Hz

UITRUSTING:

1 = PERFECTCLIME

2 = LOW GLARE 
(100% warmte bij 80% minder licht!)

3 = NO GLARE 
(100% lichtreductie!)

4 = Waterdicht 

5 = Licht 

VERMOGEN	MATERIAAL	CODE	EAN	IP AANDUIDING	AFMETINGEN (B x H x T in cm)	GEWICHT (in g)	UITRUSTING	SNOERLENGTE	STROOMA ANSLUITING
2 x 1,5 kW	Zilver	BHS3024-3	4260051487250	IP24	89,5 x 14,5 x 9,5	4000	2	3m 5-adrig 2,5mm ² , Adereindhulzen	3/N/PE ~ 400 (3N) V 50 Hz
2 x 2,0 kW	Wit	BHS4024	4260051487267	IP24	89,5 x 14,5 x 9,5	4000	2	3m 5-adrig 2,5mm ² , Adereindhulzen	3/N/PE ~ 400 (3N) V 50 Hz
2 x 2,0 kW	Wit	PCBHS40242	4260051485089	IP24	111,5 x 14,5 x 9,5	4000	1, 2	3m 5-adrig 2,5mm ² , Adereindhulzen	3/N/PE ~ 400 (3N) V 50 Hz
2 x 2,0 kW	Zilver	BHS4024-3	4260051487274	IP24	89,5 x 14,5 x 9,5	4000	2	3m 5-adrig 2,5mm ² , Adereindhulzen	3/N/PE ~ 400 (3N) V 50 Hz
3 x 2,0 kW	Wit	BHS6024	4260051487281	IP24	129 x 14,5 x 9,5	6000	2	3m 5-adrig 2,5mm ² , Adereindhulzen	3/N/PE ~ 400 (3N) V 50 Hz
3 x 2,0 kW	Wit	PCBHS60242	4260051485102	IP24	151,5 x 14,5 x 9,5	6000	1, 2	3m 5-adrig 2,5mm ² , Adereindhulzen	3/N/PE ~ 400 (3N) V 50 Hz
3 x 2,0 kW	Zilver	BHS6024-3	4260051487298	IP24	129 x 14,5 x 9,5	6000	2	3m 5-adrig 2,5mm ² , Adereindhulzen	3/N/PE ~ 400 (3N) V 50 Hz



SMART INFO IP24

2 x 1,5 kW	Wit	BHSI3024-2	4260051487342	IP24	167 x 14,5 x 9,5	8500	2	3m 5-adrig 2,5mm ² , Adereindhulzen	3/N/PE ~ 400 (3N) V 50 Hz
2 x 1,5 kW	Wit	PCBHSI3024-2	4260051482156	IP24	183 x 14,5 x 9,5	8500	1, 2	3m 5-adrig 2,5mm ² , Adereindhulzen	3/N/PE ~ 400 (3N) V 50 Hz
2 x 1,5 kW	Zilver	BHSI3024-3	4260051487359	IP24	167 x 14,5 x 9,5	8500	2	3m 5-adrig 2,5mm ² , Adereindhulzen	3/N/PE ~ 400 (3N) V 50 Hz
2 x 1,5 kW	Zilver	PCBHSI3024-3	4260051482163	IP24	183 x 14,5 x 9,5	8500	1, 2	3m 5-adrig 2,5mm ² , Adereindhulzen	3/N/PE ~ 400 (3N) V 50 Hz



REMOTE SOFTSTART DIMMER

0,25 kw	Dimmer 50/66/100%	BRFE025	4260051489285	IP54	14,4 x 48 x 20	500		Netzzuleitung 490 mm (STAS 3), Toevoer naar het verwarming 235 mm (STAK 3)	1/N/PE ~ 230 V 50 Hz
2,0 kw	Dimmer 50/66/100%	BRFE20	4260051489261	IP54	14,4 x 4,8 x 20	500		Netzzuleitung 490 mm (STAS 3), Toevoer naar het verwarming 235 mm (STAK 3)	1/N/PE ~ 230 V 50 Hz
4,0 kw	Dimmer 50/66/100%	BRFE40	4260051489278	IP56	16,7 x 15,3 x 11,8	1.000		Vast bekabeld met Anschlussklemme	1/N/PE ~ 230 V 50 Hz



REMOTE CONTROL SENDER

BiDirectional Solo 1 Kanal	Zwart	BRD_S1	4260051489209	IP20	7,4 x 4,4 x 1,5	120			
BiDirectional Solo 1 Kanal	Wit	BRD_S2	4260051489216	IP20	7,4 x 4,4 x 1,5	120			
BiDirectional Solo 1 Kanal	Zilver	BRD_S3	4260051489223	IP20	7,4 x 4,4 x 1,5	120			
BiDirectional Mono 1 Kanal	Zilver	BRD-BM3	4260051483801	IP20	5,1 x 12 x 2,6	120			
BiDirectional Mono 1 Kanal	Wit	BRD-BM2	4260051483818	IP20	5,1 x 12 x 2,6	120			
BiDirectional Mono 1 Kanal	Antraciet	BRD-BM5	4260051484204	IP20	5,1 x 12 x 2,6	120			
BiDirectional Varjo 5 Kanal	Zilver	BRD-BV2	4260051483825	IP20	5,1 x 12 x 2,6	120			
BiDirectional Varjo 5 Kanal	Wit	BRD-BV3	4260051483832	IP20	5,1 x 12 x 2,6	120			
BiDirectional Varjo 5 Kanal	Antraciet	BRD-BV5	4260051484211	IP20	5,1 x 12 x 2,6	120			



TIMER SOFTSTART

1 x 2,0 kW	Wit	TS2-C	4260051480107	IP20	9,5 x 13 x 5,5	475	1,5m 3-adrig 1,5mm ² PVC; 0,5m 3-adrig 1,5mm ² PVC, Schukostecker	1/N/PE ~ 230 V 50 Hz
1 x 4,0 kW	Wit	TS4	4260051480077	IP65	10 x 12,5 x 7	475	1,5m 3-adrig 1,5mm ² PVC; 0,5m 3-adrig 1,5mm ² PVC, Schukostecker	1/N/PE ~ 230 V 50 Hz



BH CONTROLLER 3600 ELECTRONIC SCHUKO

1 x 3,6 kW	Wit	BHC3600E-2	4260051480121	IP20	11 x 11,7 x 17	1600	3m 3-adrig 1,5 mm ² , Schukostecker	1/N/PE ~ 230 V 50 Hz
1 x 3,6 kW	Zilver	BHC3600E-3	4260051480138	IP20	11 x 11,7 x 17	1600	3m 3-adrig 1,5 mm ² , Schukostecker	1/N/PE ~ 230 V 50 Hz



BH CONTROLLER 3601 ELECTRONIC

1 x 3,6 kW	Wit	BHC3601E-2	4260051480145	IP20	11 x 11,7 x 17	1250	Vast bekabeld	1/N/PE ~ 230 V 50 Hz
1 x 3,6 kW	Zilver	BHC3601E-3	4260051480152	IP20	11 x 11,7 x 17	1250	Vast bekabeld	1/N/PE ~ 230 V 50 Hz



BH CONTROLLER 1 ZONE IP65

4,0 kw, 1 Zone	Wit	BHC4001	4260051480169	IP65	28 x 17 x 8,7	2150	2,5mm ² , Vast bekabeld	1/N/PE ~ 230 V 50 Hz
6,0 kw, 1 Zone	Wit	BHC6001	4260051481562	IP65	28 x 17 x 8,7	2150	2,5mm ² , Schukostecker	1/N/PE ~ 230 V 50 Hz
Afstandsbediening 1	Wit	BHCR1	4260051480176	IP20	4,5 x 26 x 2	80		
BPIR	Wit	BPIR	4260051485942	IP65	10 x 8 x 11,7	140		



BH CONTROLLER 9 ZONE IP65

4,0 kw, 2 Zonen	Wit	BHC4002-ER	4260051482835	IP65	28 x 17 x 8,7	2150	2,5mm ² , Vast bekabeld	1/N/PE ~ 230 V 50 Hz
6,0 kw, 3 Zonen	Wit	BHC6003-ER	4260051482842	IP65	28 x 17 x 8,7	2150	2,5mm ² , Vast bekabeld	3/N/PE ~ 400 V 50 Hz
4,0 kw, 2 Zonen	Wit	BHC4002D	4260051483443	IP65	28 x 17 x 8,7	2150	2,5mm ² , Vast bekabeld	1/N/PE ~ 230 V 50 Hz
6,0 kw, 3 Zonen	Wit	BHC6003D	4260051483450	IP65	28 x 17 x 8,7	2150	2,5mm ² , Vast bekabeld	3/N/PE ~ 400 V 50 Hz
Afstandsbediening 9	Wit	BHCR9	4260051483306	IP20	4,5 x 26 x 2	80		
Keypad	Wit	BHCK	4260051483559	IP65	28 x 17 x 8,7	2150		



BEWEGINGSMELDERS/TEMPERATUURSENSOREN

BPIR4, 4,0 kw	Wit	BPIR4	4260051485959	IP67	10 x 10 x 6	280	2,5mm ² , Vast bekabeld	1/N/PE ~ 230 V 50 Hz
BPIR6, 6,0 kw	Wit	BPIR6	4260051485966	IP67	13 x 13 x 7,5	600	2,5mm ² , Vast bekabeld	1/N/PE ~ 230 V 50 Hz



KLEMMEN

BENAMING	CODE	EAN
Klem paal voor 4 straler	KLM4	4260051489094
Klem steunbalk, 1 straler Wit	KLS1W	4260051489131
Klem steunbalk, 1 straler Zilver	KLS1S	4260051489148
Klittenbandhouder, 1 straler Wit	KLS1KW	4260051489155
Klittenbandhouder, 1 straler Zilver	KLS1KS	4260051489186

STATIEVEN

BENAMING	CODE	EAN
BH_SMART Statieven, Wit	BHSS-2	4260051487144
BH_SMART Statieven, Zilver	BHSS-3	4260051487151
BH_SMART Statieven, Zwart	BHSS-1	4260051481357

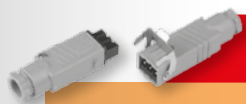

HIRSCHMANNSET

BENAMING	CODE	EAN
BRHS	STAS 3 + STAK 3 + Stasi	4260051489094



PERFECTCLIME SET PRO (COMPLETE, NO UV)

BENAMING	BENAMING	CODE	EAN
PCE05 4 PCRCA200V	SET PCE05 + Filer + 4 x PCRCA200V	PCSET4A	4260051489094
PCE05 3 PCRCA200V2	SET PCE05 + Filer + 3 x PCRCA200V2	PCSET3A2	4260051489131
PCE05 2 PCRCJ400V	SET PCE05 + Filer + 2 x PCRCJ400V	PCSET2J	4260051489148
PCE05 2 RLH2165	SET PCE05 + 2 x PCRLH2165	PCSET2LH	4260051489155
PCE05 2 RLH4265	SET PCE05 + 2 x PCRLH4265	PCSET2LHL	4260051489186
PCE05 2 RLH4265F	SET PCE05 + 2 x PCRLH4265F	PCSET2LHF	4260051485119
PCE05 2 RTT600V	SET PCE05 + 2 x PCRTT600V	PCSET2RTT	4260051482330



PERFECTCLIME POMPEN

BENAMING	CODE	EAN	DRUK	VERBRUIK
Pompen 05	PCE05	4260051482347	60 Bar	0,5 l/m
Pompen 1	PCE1	4260051482354	60 Bar	0,9 l/m
Pompen 3	PCE3	4260051482361	60 Bar	3,0 l/m

PERFECTCLIME KOPPELINGEN (6,35 mm)

BENAMING	CODE	EAN	ABBILDUNG
T - Koppelingen	PCKT	4260051483245	
L - Koppelingen	PCKL	4260051483252	
Gerade Koppelingen	PCKS	4260051483856	
End - Koppelingen	PCKE	4260051483269	
Winkel Koppelingen	PCKG	4260051483276	

PERFECTCLIME POLYAMID PIPELINE (6,35 mm)

BENAMING	CODE	EAN	ABBILDUNG
Polyamid Buis 25 cm	PCPS25	4260051483290	
Polyamid Buis 75 cm Gerte	PCPG7	4260051483313	
Polyamid Cut snijder	PCPC	4260051483320	
Polyamid Slang bevestiging	PCPB	4260051483337	



PERFECTCLIME SPROEIER

BENAMING	CODE	EAN	56 BAR VARIANTE	70 BAR VARIANTE	84 BAR VARIANTE
Sproeier Nozzle 0,15mm	PCN15	4260051483207	0,041 l/min 0.011 US Gpm	0,046 l/min 0.0095 US Gpm	0,051 l/min 0.012 US Gpm
Sproeier Nozzle 0,20mm	PCN20	4260051483214	0,080 l/min 0.021 US Gpm	0,089 l/min 0.024 US Gpm	0,098 l/min 0.026 US Gpm
Sproeier Nozzle 0,30mm	PCN30	4260051483221	0,130 l/min 0.034 US Gpm	0,145 l/min 0.038 US Gpm	0,159 l/min 0.042 US Gpm
Sproeier Nozzle 0,40mm	PCN40	4260051483238	0,159 l/min 0.047 US Gpm	0,178 l/min 0.047 US Gpm	0,195 l/min 0.052 US Gpm



PERFECTCLIME FILTER

BENAMING	CODE	EAN
Filterset Kalk	PCFKUEU	4260051483344
Partikelfilter	PCFKUEU	4260051483351



PERFECTCLIME UV-FILTER

CODE	EAN	CAPACITEIT	DRUK
PCFUV4	4260051482880	480 l/h	6 Bar
PCFUV5	4260051482897	500 l/h	7-10 Bar
PCFUV10	4260051482972	1000 l/h	7-10 Bar
PCFUV30	4260051482989	3000 l/h	7-10 Bar

BUIZEN TERM 2000 IP20/24

BENAMING	VERMOGEN	CODE	EAN	IP AANDUIDING	AFMETINGEN (Länge in cm)	GEWICHT (in g)	SNOERLENGTE	STROOMA ANSLUITING
IP20 Cable 357,5 mm	1,0 kW	LG1000	4260051486017	IP20	35,75	50	295 mm beide kanten, Adereindhulzen	1/N/PE ~ 230V 50Hz
IP20 Cable 357,5 mm	1,0 kW	LG1000V	4260051486048	IP20	35,75	50	295 mm beide kanten, Adereindhulzen	1/N/PE ~ 230V 50Hz
IP20 Cable 357,5 mm	1,5 kW	LG1500	4260051486024	IP20	35,75	50	295 mm beide kanten, Adereindhulzen	1/N/PE ~ 230V 50Hz
IP20 Cable 357,5 mm	1,5 kW	LG1500V	4260051486000	IP20	35,75	50	295 mm beide kanten, Adereindhulzen	1/N/PE ~ 230V 50Hz
IP20 Cable 357,5 mm	2,0 kW	LG2000	4260051486031	IP20	35,75	50	295 mm beide kanten, Adereindhulzen	1/N/PE ~ 230V 50Hz
IP20 Cable 357,5 mm	2,0 kW	LG2000V	4260051486055	IP20	35,75	50	295 mm beide kanten, Adereindhulzen	1/N/PE ~ 230V 50Hz
IP24 Cable 355 mm	1,0 kW	LG1024	4260051486123	IP24	35,5	50	235 mm en 590 mm, Adereindhulzen	1/N/PE ~ 230V 50Hz
IP24 Cable 355 mm	1,5 kW	LG1524	4260051486130	IP24	35,5	50	235 mm en 590 mm, Adereindhulzen	1/N/PE ~ 230V 50Hz
IP24 Cable 355 mm	2,0 kW	LG2024	4260051486147	IP24	35,5	50	235 mm en 590 mm, Adereindhulzen	1/N/PE ~ 230V 50Hz
IP24 Cable 355 mm	1,5 kW	ULGS1524V	4260051484129	IP24	35,5	50	235 mm en 590 mm, Adereindhulzen	1/N/PE ~ 230V 50Hz
IP24 Cable 355 mm	2,0 kW	ULGS2024V	4260051484136	IP24	35,5	50	235 mm en 590 mm, Adereindhulzen	1/N/PE ~ 230V 50Hz

BUIZEN TERM2000 IP65/67

BENAMING	VERMOGEN	CODE	EAN	IP AANDUIDING	AFMETINGEN (Länge in cm)	GEWICHT (in g)	SNOERLENGTE	STROOMA ANSLUITING
IP65/67 Cable 380 mm	1,0 kW	LG1001	4260051486185	IP65/67	38	50	300 mm en 920 mm, Adereindhulzen	1/N/PE ~ 230V 50Hz
IP65/67 Cable 380 mm	1,7 kW	LGS1700V	4260051485973	IP65/67	38	50	300 mm en 920 mm, Adereindhulzen	1/N/PE ~ 230V 50Hz
IP65/67 Cable 380 mm	2,0 kW	LGS2000V	4260051485980	IP65/67	38	50	300 mm en 920 mm, Adereindhulzen	1/N/PE ~ 230V 50Hz
IP65/67 Cable 529 mm	1,65 kW	LG1650	4260051486093	IP65/67	52,9	50	300 mm en 920 mm, Adereindhulzen	1/N/PE ~ 230V 50Hz
IP65/67 Cable 529 mm	2,0 kW	LG2001V	4260051486109	IP65/67	52,9	50	300 mm en 920 mm, Adereindhulzen	1/N/PE ~ 230V 50Hz
IP65/67 Cable 529 mm	1,65 kW	ULG1650V	4260051484105	IP65/67	52,9	50	300 mm en 920 mm, Adereindhulzen	1/N/PE ~ 230V 50Hz
IP65/67 Cable 529 mm	2,0 kW	ULG2001V	4260051484112	IP65/67	52,9	50	300 mm en 920 mm, Adereindhulzen	1/N/PE ~ 230V 50Hz

RÖHREN TERM IR SPA IP20

BENAMING	VERMOGEN	CODE	EAN	IP AANDUIDING	AFMETINGEN (Länge in cm)	GEWICHT (in g)	SNOERLENGTE	STROOMA ANSLUITING
IP20 Cable 500 W Vitae	0,50kW	LGIR500	4260051483597	IP20	78	50	1200mm en 230mm, Adereindhulzen	1/N/PE ~ 230V 50Hz
IP20 Cable 750 W Vitae	0,75 kW	LGIR750	4260051483603	IP20	78	50	1200mm en 230mm, Adereindhulzen	1/N/PE ~ 230V 50Hz

BUIZEN BH SMART & R7S IP20

BENAMING	VERMOGEN	CODE	EAN	IP AANDUIDING	AFMETINGEN (Länge in cm)	GEWICHT (in g)	SNOERLENGTE	STROOMA ANSLUITING
R7S Push-In 254 mm	0,8 kW	LGHR800V	4260051488189	IP20	25,4	50	Adereindhulzen	1/N/PE ~ 230V 50Hz
R7S Push-In 254 mm	1,0 kW	LGHR1000V	4260051488035	IP20	25,4	50	Adereindhulzen	1/N/PE ~ 230V 50Hz
R7S Push-In 254 mm	1,3 kW	LGHR1300V	4260051488073	IP20	25,4	50	Adereindhulzen	1/N/PE ~ 230V 50Hz
R7S Push-In 254 mm	1,3 kW	ULGR1300V	4260051484143	IP20	25,4	50	Adereindhulzen	1/N/PE ~ 230V 50Hz

BUIZEN BH SMART SK15 IP20/24

BENAMING	VERMOGEN	CODE	EAN	IP AANDUIDING	AFMETINGEN (Länge in cm)	GEWICHT (in g)	SNOERLENGTE	STROOMA ANSLUITING
IP20 Cable 350 mm	1,5 kW	LGHS1500V	4260051484877	IP20		50	300 mm aan beide kanten, Adereindhulzen	1/N/PE ~ 230V 50Hz
IP20 Cable 350 mm	2,0 kW	LGHS2000	4260051488103	IP20		50	300 mm aan beide kanten, Adereindhulzen	1/N/PE ~ 230V 50Hz
IP24 Cable 350 mm	1,5 kW	LGHS1524V	4260051480770	IP24		50	590 mm und 240 mm, Adereindhulzen	1/N/PE ~ 230V 50Hz
IP24 Cable 350 mm	2,0 kW	LGHS2024	4260051489605	IP24		50	590 mm und 240 mm, Aderendhulsen	1/N/PE ~ 230V 50Hz

NOTITIES

Wat is infrarood?

MET INTELLIGENTE TECHNIEK NAAR SUCCES

Infrarood kortegolftechnologie: Infraroodstraling is een deelgebied van het door de zon opgewekte lichtspectrum. Dit soort licht is echter voor het menselijke oog niet meer zichtbaar, het werkt alleen nog als warmtestraling. In principe geldt: hoe korter de golflengte, hoe makkelijker de lucht doordrongen wordt. Korte golf infrarood wekt warmte op door verwarming van het lichaam waar de straling tegenaan komt, zonder daarbij de omringende lucht op te warmen. Hierdoor ontstaat effectieve, nauwkeurige directe warmte zonder warmteverlies. Het komt het dichtst bij het natuurlijke verwarmingsprincipe van de zon en wordt daarom ervaren als de meest aangename warmte. Een goed voorbeeld van deze werking is het effect dat optreedt als iemand van de schaduw in de zon komt: hoewel de omgevingstemperatuur precies gelijk gebleven is, wordt de temperatuur bij directe zonnestraling als duidelijk warmer ervaren. Economisch en ecologisch, onderhoudsvriendelijk en overtuigend zuiniger toepasbaar. Voor meer voordelen en rendement in alle toepassingsgebieden.

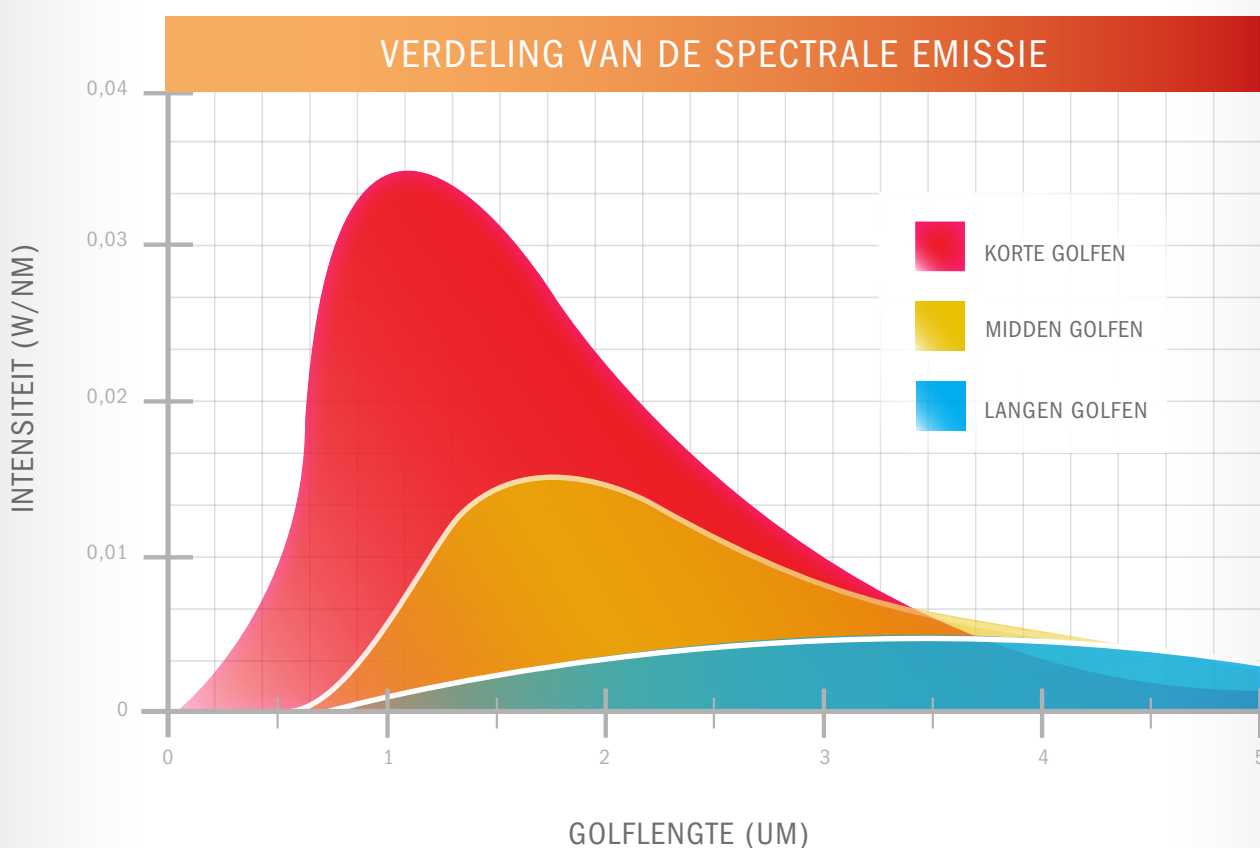

DUBBEL ZO GOED - DE NIEUWE BURDA WTG WARMTESTRALER GENERATIE „LOW GLARE“.

De nieuwe „Low Glare“ warmtestraler-serie van Burda Worldwide Technologies GmbH biedt effectieve directe warmte en een unieke kaarslichtatmosfeer. Het is voor het eerst gelukt om met „Low Glare“ een warmtestraler-buizengeneratie te ontwikkelen die dubbel gecoat is. Deze coating van de verwarmingsbuizen aan de binnen- en buitenkant vermindert de lichtstraling met ongeveer 80%. Zo ontstaat een zachte lichtbron, die aanwezige sfeerverlichting van terrassen en balkons niet beïnvloedt. Low-Glare-producten bieden een overtuigende combinatie van het effectieve verwarmingsvermogen van infrarood-kortegolftechnologie en het ideale licht voor een aangename kaarslicht-atmosfeer. In de horeca of thuis staat de nieuwe productserie „Low Glare“ garant voor een behaaglijke atmosfeer. Per direct ook verkrijgbaar in de hoogwaardige warmtestraler-series BURDA TERM 2000 IP24, IP65, IP67, de BURDA SMART 2000 IP20 en IP24, evenals voor alle PerfectClima stralers.

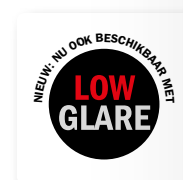

Goed om te weten

TERM 2000 VERWARMINGSOPPERVLAKKEN BIJ 45° PLAATSINGSHOEK

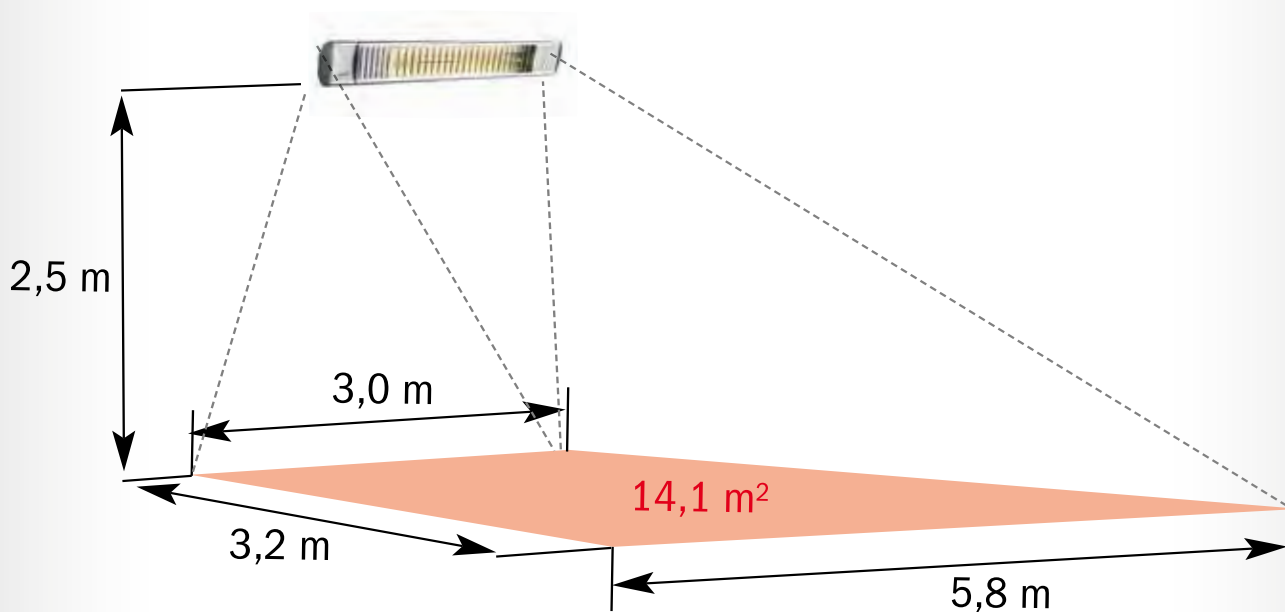

GASTOESTEL

Korte gebruiksduur

Traditionele terrasverwarmers op gas werken met 11 kg gasflessen, die na 8-11 uur vervangen moeten worden.

11 kg fles propaangas: 20,- €

Verbruik 1 kg/h:

Kosten per uur = 1,81 €

BURDA WARMTESTRALERS

Lange gebruiksduur

Infrarood kortegolfwarmtestralers hebben na **ca. 5.000 gebruiksuren** slechts een nieuwe verwarmingslamp nodig.

2 KW stroom bij huidige prijs = 2 x 0,24 €:

2.000 Watt-straler:

kosten per uur = 0,48 €

Besparing per uur =
1,33 € of meer dan 70%

Bij dezelfde kosten
= 3-4 Burda stralers
= 1 terrasverwarmer op gas

Directe warmte op 14-16 m2 bij 1.500 - 2.000 W voor 36-48 cent per uur

Uw handelaar

INTELLIGENT GEKOZEN!

Onze klanten waarderen de uitstekende kwaliteit en het grote toepassingsgebied van onze producten. In hotels en restaurants, in de industrie of voor particulier gebruik: het BURDA infrarood kortegolfttechnologie warmtestralerassortiment overtuigt de wereldwijd toonaangevende merken en industrieën. Zoals bijvoorbeeld de MS Europa, verkozen tot het beste cruiseschip ter wereld. Kies ook voor het intelligente antwoord op uw behoeften.

EEN SELECTIE VAN REFERENTIES

Internationale samenwerking

- AEG/Stiebel Eltron
- Bartscher
- Schwank

First Class Hotellerie

- Adlon
- Holiday Inn
- Hilton
- Marriott
- Sheraton
- Steigenberger
- The Century
- Vier Jahreszeiten ...

Internationale Gastronomie en koffiebar

- Blockhouse Steakhäuser
- Burger King
- Cafetiero
- Häagen-Dazs
- Hard Rock Cafe
- Le Crobag
- McDonald's
- Nordsee
- Starbucks ...

Superior Cruisehips

- AIDA Cruises
- A-Rosa Cruises
- Celebrity Cruises
- MS Europa (Das Traumschiff)

Tv-studio

- Big Brother
- Endemol

Musea en Events

- Louvre Paris – Frankreich
- Berlinale Berlin – Deutschland

Handel en industrie

- Areva
- Ford
- Mercedes
- Thyssen Krupp
- Volkswagen ...

Airlines

- Air Berlin
- Condor
- Lufthansa
- Royal Air Force
- US Army ...

BURDA WORLDWIDE TECHNOLOGIES GMBH

Rudolf-Diesel-Straße 18 · D-65760 Eschborn
Tel +49 6173/324 24 0 · Fax +49 6173/324 24 24
E-Mail info@burdawtg.com · www.burdawtg.com

Bezoek ook onze
Heating & Cooling website
www.PerfectClime.com



Bezoek onze Noord-
Amerikaanse site
www.TheHeater.com